



All Theses and Dissertations

2008-07-29

Fish Passage at UDOT Culverts: Prioritization and Assessment

Aaron Evens Beavers

Brigham Young University - Provo

Follow this and additional works at: <https://scholarsarchive.byu.edu/etd>

 Part of the [Civil and Environmental Engineering Commons](#)

BYU ScholarsArchive Citation

Beavers, Aaron Evens, "Fish Passage at UDOT Culverts: Prioritization and Assessment" (2008). *All Theses and Dissertations*. 1461.
<https://scholarsarchive.byu.edu/etd/1461>

This Thesis is brought to you for free and open access by BYU ScholarsArchive. It has been accepted for inclusion in All Theses and Dissertations by an authorized administrator of BYU ScholarsArchive. For more information, please contact scholarsarchive@byu.edu, ellen_amatangelo@byu.edu.

FISH PASSAGE AT UDOT CULVERTS: PRIORITIZATION
& ASSESSMENT

by

Aaron Evens Beavers

A thesis submitted to the faculty of

Brigham Young University

in partial fulfillment of the requirements for the degree of

Master of Science

Department of Civil and Environmental Engineering

Brigham Young University

December 2008

BRIGHAM YOUNG UNIVERSITY

GRADUATE COMMITTEE APPROVAL

of a thesis submitted by

Aaron Evens Beavers

This thesis has been read by each member of the following graduate committee and by majority vote has been found to be satisfactory.

Date

Rollin H. Hotchkiss, Chair

Date

Mark C. Belk

Date

E. James Nelson

Date

Russell B. Rader

BRIGHAM YOUNG UNIVERSITY

As chair of the candidate's graduate committee, I have read the thesis of Aaron Evens Beavers in its final form and have found that (1) its format, citations, and bibliographical style are consistent and acceptable and fulfill university and department style requirements; (2) its illustrative materials including figures, tables, and charts are in place; and (3) the final manuscript is satisfactory to the graduate committee and is ready for submission to the university library.

Date

Rollin H. Hotchkiss
Chair, Graduate Committee

Accepted for the Department

E. James Nelson
Graduate Coordinator

Accepted for the College

Alan R. Parkinson
Dean, Ira A. Fulton College of Engineering
and Technology

ABSTRACT

FISH PASSAGE AT UDOT CULVERTS: PRIORITIZATON & ASSESSMENT

Aaron Evens Beavers

Department of Civil and Environmental Engineering

Master of Science

State Departments of Transportation are becoming more involved in providing Aquatic Organism Passage (AOP) at road-stream crossings. Department of Transportation (DOT) emphasis on AOP has been driven largely in response to endangered species listings, other agencies' initiatives, and the desire to restore ecosystem connectivity to watercourses. UDOT is currently responsible for approximately 47,000 culverts, but AOP is currently addressed only on an as-needed basis. Currently UDOT has no prioritization or assessment strategy procedure for AOP at UDOT road-stream crossings. Historical fish passage strategies have focused on federally listed adult anadromous salmon and trout. These are generally very large fish whose life cycle includes both fresh and salt water environs. These species have adapted

to the wetter conditions prevalent in their Pacific Northwest habitat. However, Utah fish species have adapted to the arid conditions of the Great Basin, are generally much smaller, and complete their life cycle entirely within fresh water. For UDOT these differences represent a potential fundamental divergence in the approaches used for providing fish passage in Utah vs. those historically used in the Pacific Northwest. The purpose of this research was to develop a method of prioritizing culverts statewide and to modify existing culvert assessment procedures for UDOT within a Great Basin/Utah regional context.

Developed as part of the research are tools to prioritize and assess culverts. A GIS database was developed to store fish passage assessment data as well as provide functions for prioritizing culverts on the state and regional level. A fish passage assessment protocol for assessing UDOT culverts was developed based on existing fish passage assessments. The culvert assessment was tailored to meet developed UDOT fish passage strategies. A training manual was also created to aid technicians on performing the several physical culvert assessments developed. Additionally, a mark and recapture study at six UDOT culverts was performed to field verify the developed culvert assessment procedure. A step by step methodology was then created to establish critical progression for prioritizing and assessing culverts for fish passage utilizing project results.

ACKNOWLEDGMENTS

I would like to thank my family; my wife Pamela, my sons Ashton, Alex and Dalon and my daughters Delene and Rochelle for putting up with late nights, missed family events and an otherwise crazy husband and father over the last four years. I would also like to thank UDOT for funding my project and for the feedback and help I received from Mr. Fazio and Mr. Stuhff. I also want to thank Dr. Hotchkiss for his guidance and patience in helping me to produce this document while under the duress of my wife's accident and the unpredictable fallout which occurred because of it. I also want to thank Dr. Belk for his contributions. His generosity in showing me great places to hunt and fish provided a rich outlet to go recharge my batteries depleted from school and life. Finally I want to thank Dr. Rader and Dr. Nelson for being on my graduate committee and providing me with timely assistance when I required it.

TABLE OF CONTENTS

LIST OF TABLES	xi
LIST OF FIGURES	xiii
1 Introduction.....	1
1.1 Scope.....	2
1.2 Objectives	2
1.3 Document Organization.....	3
2 UDOT Fish Passage Strategy	5
3 Fish Passage Prioritization.....	7
3.1 Purpose.....	7
3.2 Methods	7
3.3 Data Collection	8
3.4 Data Evaluation.....	8
3.5 Results.....	9
3.5.1 General Database Format.....	9
3.5.2 UDOT_culverts.shp	10
3.5.3 Utah_CAPI.shp	10
3.5.4 Hydraulic Evaluation	12
3.5.5 Listed Species Index (LSI).....	20
3.5.6 Habitat Fragmentation Index (HFI)	24

3.5.7	Culvert Priority Indicator (CPI)	25
3.5.8	Fish_passage_calibration.xls	27
4	Fish Passage Assessment	29
4.1	Purpose.....	29
4.2	Methods	29
4.3	Data Collection	30
4.4	Data Evaluation.....	31
4.4.1	Physical Assessment Data.....	31
4.4.2	Fish Screens	33
4.5	Fish Passage Assessment Format	35
5	Assessment Training.....	39
5.1	Methods	39
5.2	Data Collection	39
5.3	Data Evaluation.....	40
5.4	Results.....	40
6	Field Verification of the Fish Passage Assessment.....	43
6.1	Methods	43
6.2	Data Collection	44
6.2.1	Site Selection	44
6.2.2	Mark	54
6.2.3	Fish Passage Assessment	58
6.2.4	Recapture	59
6.3	Data Evaluation.....	60
6.3.1	Results.....	67

7	Project Summary & Conclusions	69
8	Recommendations	71
8.1	Fish Passage Prioritization & Assessment Implementation Plan	71
8.2	GIS Database Context.....	74
8.3	Recommended Automation for GIS Database.....	75
8.4	GIS Database Resources	76
8.5	Culvert Assessment Resources	77
8.6	Implementations Beyond UDOT Scope	78
8.6.1	Calibrating Hydraulic Software	78
8.6.2	Statewide Culvert Prioritization Methods.....	79
8.6.3	Hydraulic Evaluation and Filter	79
	References	81
	Appendix A UDWR Sensitive Species List	83
	Appendix B Examples of Culvert Assessment Procedures	87
	Appendix C Field Verification Data.....	113
	Appendix D Assessment Training Manual.....	161

LIST OF TABLES

Table 6-1: Mark and Recapture Dates for Field Validation Sites.....	44
Table 6-2: General Culvert Dimensions of Culverts at Field Verification Sites	48
Table 6-3: Fish Passage Prediction Produced by Coffman Fish Screens	59
Table 6-4: Observations of Downstream Marked Fish Passing Completely Through the Culvert in the Upstream Direction.....	59
Table 6-5: Coffman Fish Screen Predictions Compared to Observed Fish Passage Data.....	61
Table C-1: Capture Data for Upstream Fish Population at Soldier Creek Mark and Recapture Site	114
Table C-2: Capture Data for Downstream Fish Population at Soldier Creek Mark and Recapture Site	115
Table C-3: Capture Data for Downstream Fish Population at Diamond Fork #1 Mark and Recapture Site	116
Table C-4: Capture Data for Upstream Fish Population at Diamond Fork #1 and Downstream Population at Diamond Fork #2 Mark and Recapture Sites. This is the Transect Between These Two Culverts	117
Table C-5: Capture Data for Upstream Fish Population at Diamond Fork #2 Mark and Recapture Site	117
Table C-6: Capture Data for Upstream Fish Population at Salina Creek Mark and Recapture Site	118
Table C-7: Capture Data for Downstream Fish Population at Salina Creek Mark and Recapture Site	119
Table C-8: Capture Data for Downstream Fish Population at Daniel's Creek #1 Mark and Recapture Site	120
Table C-9: Capture Data for Upstream Fish Population at Daniel's Creek #1 and Downstream Population at Daniel's Creek #2 Mark and Recapture Sites. This is the Transect between These Two Culverts	121

Table C-10: Capture Data for Upstream Fish Population at Daniel’s Creek #2 Mark and Recapture Site	122
Table C-11: Recapture Data for Downstream Transect at Soldier Creek Mark and Recapture Site	123
Table C-12: Recapture Data for Upstream Transect at Soldier Creek Mark and Recapture Site	124
Table C-13: Recapture Data for Downstream Transect at Diamond Fork #1 Mark and Recapture Site	125
Table C-14: Recapture Data for Middle Transect Between Diamond Fork #1 and Diamond Fork #2 Mark and Recapture Sites.....	125
Table C-15: Recapture Data for Upstream Transect at Diamond Fork #2 Mark and Recapture Site	126
Table C-16: Recapture Data for Downstream Transect at Salina Creek Mark and Recapture Site	127
Table C-17: Recapture Data for Upstream Transect at Salina Creek Mark and Recapture Site	128
Table C-18: Recapture Data for Downstream Transect of Daniel’s Creek #1 Mark and Recapture Site	129
Table C-19: Recapture Data for Middle Transect of Daniel’s Creek #1 and #2 Mark and Recapture Site	130
Table C-20: Recapture Data for Upstream Transect of Daniel’s Creek #2 Mark and Recapture Site	131

LIST OF FIGURES

Figure 3-1: Fish Passage Culvert Shapefile UDOT_culverts.shp.....	11
Figure 3-2: Utah State Culvert Assessment Priority Index Shapefile.....	12
Figure 3-3: Hydraulic Evaluation Photo of a Culvert Outlet.....	14
Figure 3-4: Hydraulic Evaluation Photo of a Culvert Inlet.....	14
Figure 3-5: Hydraulic Evaluation Photo of a Culvert Outlet.....	15
Figure 3-6: Hydraulic Evaluation Photo of a Culvert Inlet.....	15
Figure 3-7: Hydraulic Filter Used With the Hydraulic Evaluation.....	21
Figure 3-8: List of Fish on UDWR SSL.....	23
Figure 3-9: Fish_passage_calibration.xls File for Storing Fish Passage Assessment Data and Generating Data to Calibrate Hydraulic Software for Further Assessing Culverts.....	27
Figure 4-1: Page 1 of Fish Passage Assessment Field Data Sheet Used to Collect Physical Culvert Data. The Entire Document is Found in Appendix D.....	37
Figure 4-2: UDOT YOY Salmonid & Cyprinidae Fish Screen Used to Derive Fish Passage Status of This Functional Group Using Physical Data Collected From a Fish Passage Assessment (Modified Coffman 2005). All Fish Screens Are Located in Appendix D.....	38
Figure 6-1: Travel Routes Taken to Find Appropriate Culvert Sites for Field Verification Study.....	46
Figure 6-2: Locations of the Four Field Sites Used in the Field Verification Study.....	47
Figure 6-3: Diamond Fork Culvert #1 Outlet (Diamond Fork Field Verification Site).....	48
Figure 6-4: Diamond Fork Culvert #1 Inlet (Diamond Fork Field Verification Site).....	49
Figure 6-5: Diamond Fork Culvert #2 Outlet (Diamond Fork Field Verification Site).....	49

Figure 6-6: Diamond Fork Culvert #2 Inlet (Diamond Fork Field Verification Site)	50
Figure 6-7: Salina Creek Culvert Outlet (Salina Creek Field Verification Site)	50
Figure 6-8: Salina Creek Culvert Inlet (Salina Creek Field Verification Site).....	51
Figure 6-9: Soldier Creek Culvert Outlet (Soldier Creek Field Verification Site).....	51
Figure 6-10: Soldier Creek Culvert Inlet (Soldier Creek Field Verification Site).....	52
Figure 6-11: Daniel’s Creek Culvert #1 Outlet (Daniels Creek Field Verification Site)	52
Figure 6-12: Daniel’s Creek Culvert #1 Inlet (Daniels Creek Field Verification Site)	53
Figure 6-13: Daniel’s Creek Culvert #2 Outlet (Daniels Creek Field Verification Site)	53
Figure 6-14: Daniel’s Creek Culvert #2 Inlet (Daniels Creek Field Verification Site).....	54
Figure 6-15: Collecting Fish Specimens by Electro-shocking and Netting Methods Downstream of Salina Creek Culvert	55
Figure 6-16: Specimens Collected in Block Net Downstream of Salina Creek Culvert	56
Figure 6-17: Measuring Standard Length of Bonneville Cutthroat Trout at Salina Creek Site	56
Figure 6-18: Tagging a Leatherside Chub Near the Base of the Caudal Fin at the Salina Creek Site.....	57
Figure 6-19: Yellow Subcutaneous Epoxy Tag Near the Base of the Caudal Fin.....	57
Figure 6-20: Yellow Subcutaneous Epoxy Tag Anterior and Posterior of Fish Eye.....	58
Figure 6-21: Orientation of Baffles in Diamond Fork #2 Culvert (Looking Downstream) ..	62
Figure 6-22: Close-up of Sediment Filled Section of Fish Baffles in Diamond Fork #2 Culvert.....	63
Figure 6-23: Salina Creek Culvert Outlet and Wildlife Trail Looking Downstream	64
Figure 6-24: Salina Creek Outlet and Wildlife Trail Looking Upstream	65
Figure 8-1: Flow Chart Outlining the FPAIP	72
Figure A-1: Introduction to UDWR SSL.....	84
Figure A-2: List of Fish on UDWR SSL	85

Figure B-1: Page 1 of U.S. Forest Service National Inventory & Assessment Procedure (Clarkin et al. 2003)	88
Figure B-2: Page 2 of U.S. Forest Service National Inventory & Assessment Procedure (Clarkin et al. 2003)	89
Figure B-3: Page 3 of U.S. Forest Service National Inventory & Assessment Procedure (Clarkin et al. 2003)	90
Figure B-4: Page 4 of U.S. Forest Service National Inventory & Assessment Procedure (Clarkin et al. 2003)	91
Figure B-5: Page 5 of U.S. Forest Service National Inventory & Assessment Procedure (Clarkin et al. 2003)	92
Figure B-6: Page 6 of U.S. Forest Service National Inventory & Assessment Procedure (Clarkin et al. 2003)	93
Figure B-7: Page 7 of U.S. Forest Service National Inventory & Assessment Procedure (Clarkin et al. 2003)	94
Figure B-8: Page 1 of the USFWS Maine Road Crossing Survey Manual Draft-E (Abbot 2007)	95
Figure B-9: Page 2 of the USFWS Maine Road Crossing Survey Manual Draft-E (Abbot 2007)	96
Figure B-10: Page 1 WDFW (2000) Fish Passage Barrier Assessment	97
Figure B-11: Page 2 WDFW (2000) Fish Passage Barrier Assessment	98
Figure B-12: Page 3 WDFW (2000) Fish Passage Barrier Assessment	99
Figure B-13: Page 4 WDFW (2000) Fish Passage Barrier Assessment	100
Figure B-14: Page 5 WDFW (2000) Fish Passage Barrier Assessment	101
Figure B-15: Page 6 WDFW (2000) Fish Passage Barrier Assessment	102
Figure B-16: Page 7 WDFW (2000) Fish Passage Barrier Assessment	103
Figure B-17: Page 1 of the Love (2003) Fish Passage Evaluation at Stream Crossings	104
Figure B-18: Page 2 of the Love (2003) Fish Passage Evaluation at Stream Crossings	105
Figure B-19: Page 3 of the Love (2003) Fish Passage Evaluation at Stream Crossings	106

Figure B-20: Salmonid Fish Screen Love (2003) Fish Passage Evaluation at Stream Crossings.....	107
Figure B-21: Coffman (2005) Group (A) Adult Salmonid Fish Screen	108
Figure B-22: Coffman (2005) Group (B) Young of Year Salmonid & Cyprinidae Fish Screen.....	109
Figure B-23: Coffman (2005) Group (C) Cottidae & Percidae Fish Screen	110
Figure B-24: USFS (Unpublished) Region 1 Adult Salmonid Fish Screen	111
Figure B-25: USFS (Unpublished) Region 1 Juvenile Salmonid Fish Screen	112
Figure C-1: Page 1 of Fish Passage Assessment of Daniel’s Creek #2 Culvert	132
Figure C-2: Page 2 of Fish Passage Assessment of Daniel’s Creek #2 Culvert	133
Figure C-3: Page 3 of Fish Passage Assessment of Daniel’s Creek #2 Culvert	134
Figure C-4: Page 4 of Fish Passage Assessment of Daniel’s Creek #2 Culvert	135
Figure C-5: Page 5 of Fish Passage Assessment of Daniel’s Creek #2 Culvert	136
Figure C-6: Page 1 of Fish Passage Assessment of Soldier Creek Culvert	137
Figure C-7: Page 2 of Fish Passage Assessment of Soldier Creek Culvert	138
Figure C-8: Page 3 of Fish Passage Assessment of Soldier Creek Culvert	139
Figure C-9: Page 4 of Fish Passage Assessment of Soldier Creek Culvert	140
Figure C-10: Page 5 of Fish Passage Assessment of Soldier Creek Culvert	141
Figure C-11: Page 1 of Fish Passage Assessment of Salina Creek Culvert.....	142
Figure C-12: Page 2 of Fish Passage Assessment of Salina Creek Culvert.....	143
Figure C-13: Page 3 of Fish Passage Assessment of Salina Creek Culvert.....	144
Figure C-14: Page 4 of Fish Passage Assessment of Salina Creek Culvert.....	145
Figure C-15: Page 5 of Fish Passage Assessment of Salina Creek Culvert.....	146
Figure C-16: Page 1 of Fish Passage Assessment of Daniel’s Creek #1 Culvert	147
Figure C-17: Page 2 of Fish Passage Assessment of Daniel’s Creek #1 Culvert	148

Figure C-18: Page 3 of Fish Passage Assessment of Daniel's Creek #1 Culvert	149
Figure C-19: Page 4 of Fish Passage Assessment of Daniel's Creek #1 Culvert	150
Figure C-20: Page 5 of Fish Passage Assessment of Daniel's Creek #1 Culvert	151
Figure C-21: Page 1 of Combined Fish Passage Assessment of Diamond Fork #1 & #2 Culverts	152
Figure C-22: Page 2 of Combined Fish Passage Assessment of Diamond Fork #1 & #2 Culverts	153
Figure C-23: Page 3 of Combined Fish Passage Assessment of Diamond Fork #1 & #2 Culverts	154
Figure C-24: Page 4 of Combined Fish Passage Assessment of Diamond Fork #1 & #2 Culverts	155
Figure C-25: Page 5 of Combined Fish Passage Assessment of Diamond Fork #1 & #2 Culverts	156
Figure C-26: Page 6 of Combined Fish Passage Assessment of Diamond Fork #1 & #2 Culverts	157
Figure C-27: Page 7 of Combined Fish Passage Assessment of Diamond Fork #1 & #2 Culverts	158
Figure C-28: Page 8 of Combined Fish Passage Assessment of Diamond Fork #1 & #2 Culverts	159
Figure C-29: Page 9 of Combined Fish Passage Assessment of Diamond Fork #1 & #2 Culverts	160

1 Introduction

Increasing emphasis has been placed on local, state and federal agencies to provide fish passage at culverts. This increased emphasis has expanded agency responsibilities for locating, assessing and managing culverts. UDOT alone is responsible for over 47,000 culverts statewide. The large number of culverts coupled with the large amount of data collection required for culvert assessment, maintenance and design, has agencies scrambling to comply by tracking and managing culverts for fish passage. Additionally, state and regional agencies have struggled with ways to best coordinate what is in reality a multi-agency task.

Fish passage at culverts has historically focused on providing passage for adult anadromous salmonid species of the Pacific Northwest. This focus is a product of the powerful social and economic status they retain as a source of recreation, food and community symbol. These are large bodied fish that spend their adult life in the ocean and return to freshwater rivers and streams to spawn. Their young may spend up to a year in fresh water and subsequently migrate to the ocean where they develop into mature adults.

Over time ideological changes regarding the passage of non-salmonid fish have shaped the current focus in providing fish passage at culverts. The latest paradigm shift incorporates the passage of all life stages of salmonid and non-salmonid fish as well as

non-fish species such as frogs, crayfish, and other organisms whose life cycle is somehow associated with potential migration within stream and river corridors. This new focus has been coined as Aquatic Organism Passage (AOP).

This shift in fish passage focus to AOP has not yet been accompanied by a corresponding trend in the development of culvert design and assessment tools. Current design and assessment tools are still heavily weighted toward passing salmonid species.

For UDOT these conditions represent a potential fundamental divergence in the anticipated methods used for providing fish passage in Utah vs. those historically developed in the Pacific Northwest for salmonids. The purpose of this research was to identify, modify and/or incorporate current fish passage methods into UDOT design and assessment procedures within a Great Basin/Utah regional context.

1.1 Scope

Project objectives restricted the scope of this study to identifying, modifying, and/or developing fish passage technology for road-stream crossings consisting of single or multiple barrel culverts traversed by UDOT-managed roads and highways.

1.2 Objectives

- Develop a strategy for prioritizing culverts for fish passage
- Create a pilot assessment database for UDOT based upon assessment results
- Determine an appropriate assessment protocol for Utah and test it in the field

1.3 Document Organization

The document begins with UDOT fish passage strategy detailing fish passage ideals developed to govern agency-wide fish passage strategy. It contains the core values governing the collection and evaluation of data used to develop the project deliverables.

The Fish Passage Prioritization, Fish Passage Assessment, and Assessment Training sections follow. These sections deal with the content of fish passage prioritization, fish passage assessment, and training manual procedures and tools developed to fulfill the project objectives. Each section contains the methods, data collection, and data evaluation used to develop the deliverables and final results.

The Field Verification section follows. It contains the methods, data collection and data evaluation used to field validate the culvert assessment procedure developed as part of this project.

The conclusion section follows and summarizes the project objectives. Recommendations conclude the main part of the report and cover the context and resources needed to successfully implement the project deliverables. This section also presents additional resources for UDOT use with the project deliverables.

Appendix A contains the Utah Department of Wildlife Resource's (UDWR) Sensitive Species List (SSL). This list contains fish species in Utah that have some associated degree of federal/state protection or concern. Appendix B provides examples of current culvert assessments used to help develop a culvert assessment procedure for UDOT. Appendix C comprises data collected as part of the field verification for the culvert assessment procedure developed for this project. Appendix D contains the training manual associated with the developed culvert assessment protocol. This manual

was relegated to the appendices due to its formatting; it contains its own table of contents and list of figures.

2 UDOT Fish Passage Strategy

Initial meetings to develop UDOT fish passage prioritization strategies were held in a multi-agency setting with input coming from BYU researchers and employees of UDOT, the United States Forest Service (USFS), the Utah Department of Wildlife Resources (UDWR), and the Central Utah Water Conservancy District (CUWCD).

The consensus of these meetings indicated that UDOT fish passage assessment and design should focus on providing passage for the weakest swimmer/leaper species in the watershed and that prioritization should be based on endangered status. The weakest swimmer/leaper concept has been termed *least species* passage by BYU researchers.

Due to the difficulty of providing specific fish passage tools for a wide range of individual fish species, individual species may also be assembled into functional groups that represent a general body form, size and swim behavior for that assemblage of species; namely (1) adult salmonids, (2) juvenile or young of year salmonids and mid-water minnows, and (3) benthic fish. The expectation is that most of the variation in swim performance is between functional groups rather than among individual species within those groups. Developing culvert assessment and design tools along functional group lines would make the design and assessment of culverts more predictable and standardized thus streamlining the process and decreasing costs.

A discussion of possible functional groups developed:

- Group 1
 - All species of adult salmonids
- Group 2
 - All species of juvenile or young of year salmonids
 - Species classified as mid-water minnows
- Group 3: Benthic
 - Species such as cottids and catostomids

From the functional groups strategy another UDOT project was funded. BYU researchers are currently performing flume tests on Utah fish species to determine swim speeds and behavior along functional group lines.

Additional strategy was developed for prioritizing culverts for performing fish passage assessments. Prioritization should consider endangered or threatened fish species as precedent for establishing priority. Culverts located in watersheds with greater numbers of listed or threatened fish species should receive higher priority.

3 Fish Passage Prioritization

3.1 Purpose

Decide how to rank culverts for field assessments of fish passage and provide UDOT with a developed method of the same.

3.2 Methods

Leading organizations in the fish passage arena rely heavily on databases as a method for formatting, storing, tracking and accessing/disseminating fish passage information. Industry-wide focus is moving toward databases that provide (1) a format to manage culverts at the watershed scale, (2) are multi-agency accessible, and (3) provide data retrieval, input and revision authorization to multiple agencies.

UDOT currently does not have a database in use for prioritizing culverts for fish passage or storing fish passage data related to culverts. Research into GIS fish passage databases was conducted to provide UDOT with a simplified database showcasing GIS capabilities related to fish passage. GIS database functions were developed to focus on prioritizing culverts statewide for fish passage assessment as well as storing fish passage data.

3.3 Data Collection

Research conducted to identify potential GIS databases was performed by literature review, internet search, and agency solicitation. Existing culvert databases used for fish passage applications were identified for further study using the following set of parameters:

- GIS based
- Database format related to fish passage at culverts
- Application of database at state or regional level
- Currently used by an agency with established fish passage experience
- Compatible with developed UDOT fish passage strategy

Initial research produced three databases found to be useful for UDOT:

- Alaska Dept. of Fish & Wildlife Fish Passage Inventory Database (ADFG 2008)
- CalFish California Fish Passage Assessment Database (CalFish 2008)
- U.S. Fish & Wildlife Service Fish Passage Decision Support System (USFWS 2008)

3.4 Data Evaluation

Functions and data storage formats of the several selected GIS databases used to help create a UDOT GIS database were evaluated based on compatibility with least species and endangered status strategies.

Possible database functions and capabilities were discussed among, BYU researchers and employees of UDOT, the United States Forest Service (USFS), the Utah

Department of Wildlife Resources (UDWR), and the Central Utah Water Conservancy District (CUWCD) as well as with Dr. Steven Barfuss and Vance Twitchell of Utah State University.

3.5 Results

3.5.1 General Database Format

The GIS database developed for UDOT includes the following shapefiles obtained from the Utah Automated Geographic Reference Center (AGRC):

- Image data (Utah orthophotographic 1 meter resolution images)
- Topography data (Utah USGS 7.5 minute quad maps)
- Hydrology data (Rivers & Streams): SGID100_StreamsTIGER2000.shp

The database includes the following GIS shapefiles obtained from Chris Glazier of the UDOT Engineering Technology Systems Division:

- Route data: routes06.shp
- Road-crossing data: pontis_sde.shp

The database includes the following GIS shapefile obtained from UDWR:

- Utah threatened and listed fish habitat distribution data: tes_20080220.shp

The following files and assessment tools were created specifically for the database and are discussed further in this section:

- UDOT_culverts.shp
- Utah_CAPI.shp
- Hydraulic Filter
- Hydraulic Evaluation
- Listed Specie Index (LSI)
- Habitat Fragmentation Index (HFI)
- Culvert Priority Indicator (CPI)
- Fish_passage_calibration.xls

3.5.2 UDOT_culverts.shp

The UDOT_culverts.shp shapefile was generated in GIS to spatially display Utah culvert locations and assist in prioritizing culverts and store fish passage prioritization and assessment data (figure 3-1).

3.5.3 Utah_CAPI.shp

The Utah_CAPI.shp file initializes culvert prioritization at the state level (figure 3-2). Using UDOT fish passage strategy guidance, regional areas were identified and delineated based on value related to threatened and otherwise listed fish concentrations. This value is derived from habitat distribution data obtained for all threatened and listed fishes found on the UDWR SSL located in Appendix A.

S denotes prioritization code for the state level. Culverts in those areas with the lowest CAPI value are defined as having the highest priority for the next phase of prioritization.

- S1: Highest Priority (Greatest concentration of threatened and listed fishes)
- S2: High Priority
- S3: Low Priority
- S4: Lowest Priority (Least concentration of threatened and listed fishes)

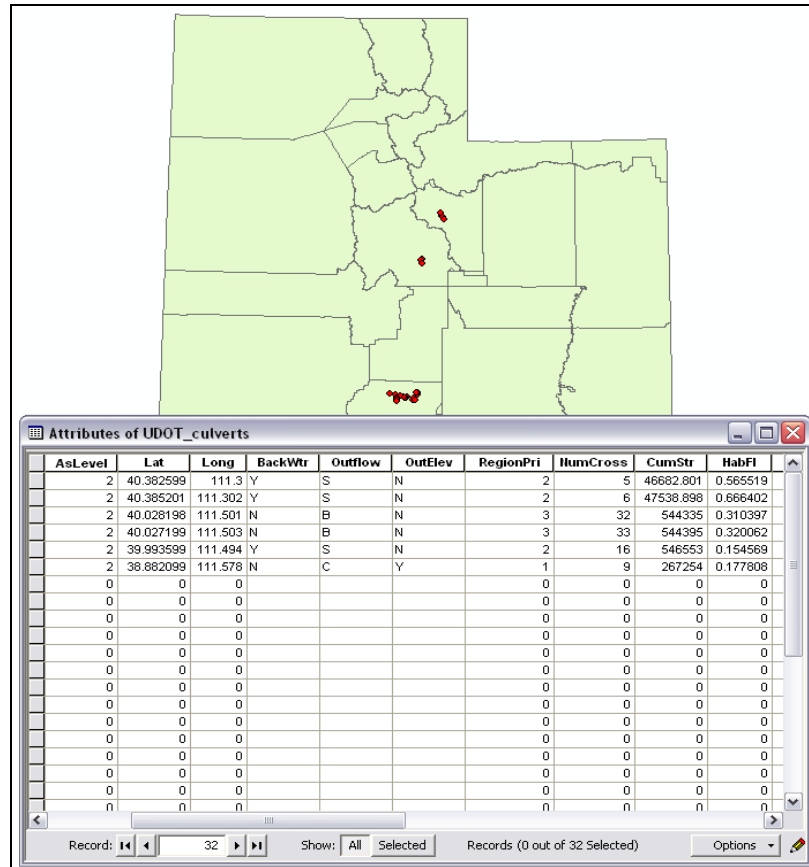

Figure 3-1: Fish Passage Culvert Shapefile UDOT_culverts.shp

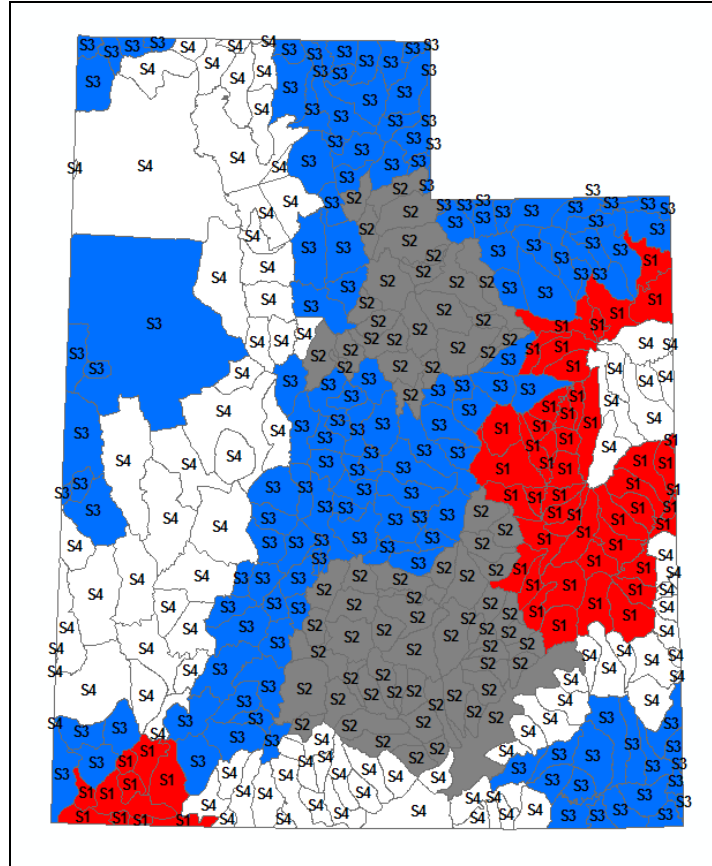

Figure 3-2: Utah State Culvert Assessment Priority Index Shapefile

3.5.4 Hydraulic Evaluation

The hydraulic evaluation was developed to use as a method of further prioritizing culverts. Using this method culverts are ranked according to their perceived ability to pass fish based on an analysis of a culvert's hydraulics at non-peak flows. Traditionally field culvert assessments taken with respect to fish passage are performed during times coinciding with the non-peak discharge. Practical purposes for using this same time frame for performing the hydraulic evaluation (1) allows the evaluation to be safely performed during lower flows outside the peak hydrograph window and (2) does not

restrict the time frame in which these evaluations can be performed allowing more to be conducted over the course of a year.

The hydraulic evaluation takes approximately 4-5 minutes to perform. All culvert data are reflected in photographs taken of the culvert inlet and outlet (refer to figures 3-3 through 3-6). Definitions of the collected data as well as other details describing how the hydraulic evaluation is performed are located in Appendix D. Data depicted in the photos:

- Date: Month/Day/Year
- Inlet or Outlet
- GPS coordinates of culvert inlet
- Outlet elevation status: “Perched” or “Not Perched”
- Outlet flow status: “Critical” or “Sub-critical”
- Culvert backwater status: “Backwatered” or “Not Backwatered”

Data collected from the hydraulic evaluation is used to populate the hydraulic filter (figure 3-7). This filter is meant to be a rough predictor and not an exact or precise evaluation of the culvert’s hydraulics at all flows. Hydraulic conditions during non-peak flows can give some indication of possible hydraulic conditions at higher flows. The filter is also not mean to be a precise fish passage assessment but a rough predictor of conditions which are adverse or beneficial to fish passage.



Figure 3-3: Hydraulic Evaluation Photo of a Culvert Outlet



Figure 3-4: Hydraulic Evaluation Photo of a Culvert Inlet



Figure 3-5: Hydraulic Evaluation Photo of a Culvert Outlet



Figure 3-6: Hydraulic Evaluation Photo of a Culvert Inlet

The emphasis here is that the filter is merely an oversimplification of possible hydraulic conditions which have an influence on generalizing a prediction of fish passage through culverts based on observations made at non-peak flows. Prioritization values are formatted so the R denotes prioritization for the regional level:

- R1: Highest Priority
- R2: High Priority
- R3: Lowest Priority

Organizations should not feel limited or restricted in applying these technologies as they are presented here. Culvert prioritization using the hydraulic filter could be supplemented using the culvert photographs taken as part of the hydraulic evaluation. Professionals and managers can assess both the available data and photos to draw their own conclusions on culvert priority. Using all available data prioritization status of individual culverts may be (1) confirmed, (2) ranked higher or (3) ranked lower. The hydraulic filter and evaluation are mean to be tools. Like many tools their application can be tailored to design needs. Additional photos can be taken to help in this regard in very little time. These might include:

- Photo to include both the outlet and tailwater control
- Upstream photo of stream channel from culvert embankment
- Downstream photo of stream from culvert embankment

The hydraulic filter was developed based on the following simplifications/assumptions. (1) Although some culverts containing fish baffles may possibly impede fish passage the presence of baffles indicates prior fish passage evaluation at the culvert in question and the culvert is considered to be less of a priority in the ranking scheme. Also, culverts possessing fish baffles should have gone through a monitoring period post-construction to determine the effectiveness of the design. If the fish passage effectiveness of identified baffled culverts has not been monitored these culverts should be populated to a list of culverts for future fish passage monitoring. Additionally, monitoring procedures for baffled culverts lay outside the scope of a common fish passage assessment for which the hydraulic evaluation was designed to prioritize culverts for. For agencies lacking such monitoring protocol, procedures should be developed to facilitate the monitoring of baffle designed culverts. The deviation from fish passage assessment to design monitoring for fish passage represents a fundamental shift in focus which requires additional tools outside the scope of a common fish passage assessment. This does not indicate that these culverts are less of a priority for future fish passage evaluation, only that a fish passage assessment is not well suited for monitoring purposes. In general baffled culverts were given an R3 priority based on:

- Already evaluated at some level for fish passage
- Better suited for monitoring program, not assessment

(2) Culverts defined as perched or elevated may become backwatered to some degree if the tailwater elevation increases due to an increase in discharge (and thus may pass certain fish at higher flows). This situation is subject to the unique conditions of the

culvert/channel/floodplain relationship and is very unpredictable. Elevated outlet inverts are generally subject to a fish's leaping ability. Due to the least species concept developed previously in section two of this document any perched condition may totally preclude the passage of certain fish species which have not displayed the ability or propensity for leaping. In general culverts with perched or elevated outlet inverts were given an R1 priority based on:

- Assumed non-passage of smaller species due to elevated culvert outlet invert
- Tailwater effects on perch or elevated outlet are unknown/unpredictable

(3) Sufficiently backwatered culverts defined as the tailwater control elevation being greater than that of the culvert inlet invert are generally considered to pass fish at all discharges. This assumption comes from previous work in fish passage. In general backwatered culverts were given an R1 priority due to the work done by:

- Love (2003)
- Coffman (2005)

(4) Assuming tailwater elevation is not constant; culverts containing critical flow throughout their entire length at base flows have a greater relative magnitude of discharge to reach before any degree of flow could possibly switch to sub-critical (hydraulic jump occurs in culvert). Assuming tailwater control is constant; culverts containing critical flow throughout their entire length at base flows are not likely to become backwatered (sub-critical flows) to any degree and critical flow is assumed for all discharges. In general differences between R1 and R2 priority are:

- Critical flow is less advantageous than sub-critical flow for fish traversing culverts in the upstream direction
- Culverts containing only critical flow are less likely to pass fish than those possessing both critical and sub-critical flow
- If the tailwater elevation is not constant culverts containing only critical flow at base flows require a greater relative change in discharge to become completely backwatered
- If tailwater elevation is constant culverts possessing critical flow throughout their length will not switch to any degree of sub-critical flow
- Inlet control is less advantageous than outlet control for fish traversing culverts in the upstream direction

The hydraulic prioritization values are based on the following possible non-peak culvert hydraulics:

- R1
 - Perched or elevated outlet
 - Hydraulic drop at the inlet and/or inlet control
 - Critical depth throughout culvert (no hydraulic jump)
- R2
 - In-barrel change between inlet and outlet control
 - Hydraulic jump in culvert
 - Outlet is backwatered

- R3
 - Outlet control
 - No hydraulic jump
 - Sub-critical flow throughout majority of culvert

Additional information regarding the hydraulic evaluation is contained in the UDOT Culvert Assessment Training Manual found in Appendix D. This document contains training and implementation information regarding the methodology of performing a hydraulic evaluation and a fish passage assessment (section 4). The hydraulic evaluation is a rough rapid assessment used to help prioritize culverts regionally using the hydraulic filter, while the fish passage assessment is a more sophisticated or comprehensive assessment used to derive an actual fish passage status of a particular culvert.

3.5.5 Listed Species Index (LSI)

The LSI is a method of assigning assessment priority value to listed and threatened fish species inhabiting the culvert watershed. Greater value is given to those species whose threatened condition is considered to be greater, such as federally endangered/threatened species.

The UDWR tes_20080220.shp file provides Utah listed/threatened fish distribution data in USGS 7.5 minute quad polygons. Using Utah Digital Elevation Model (DEM) data the appropriate culvert watershed can be delineated in GIS.

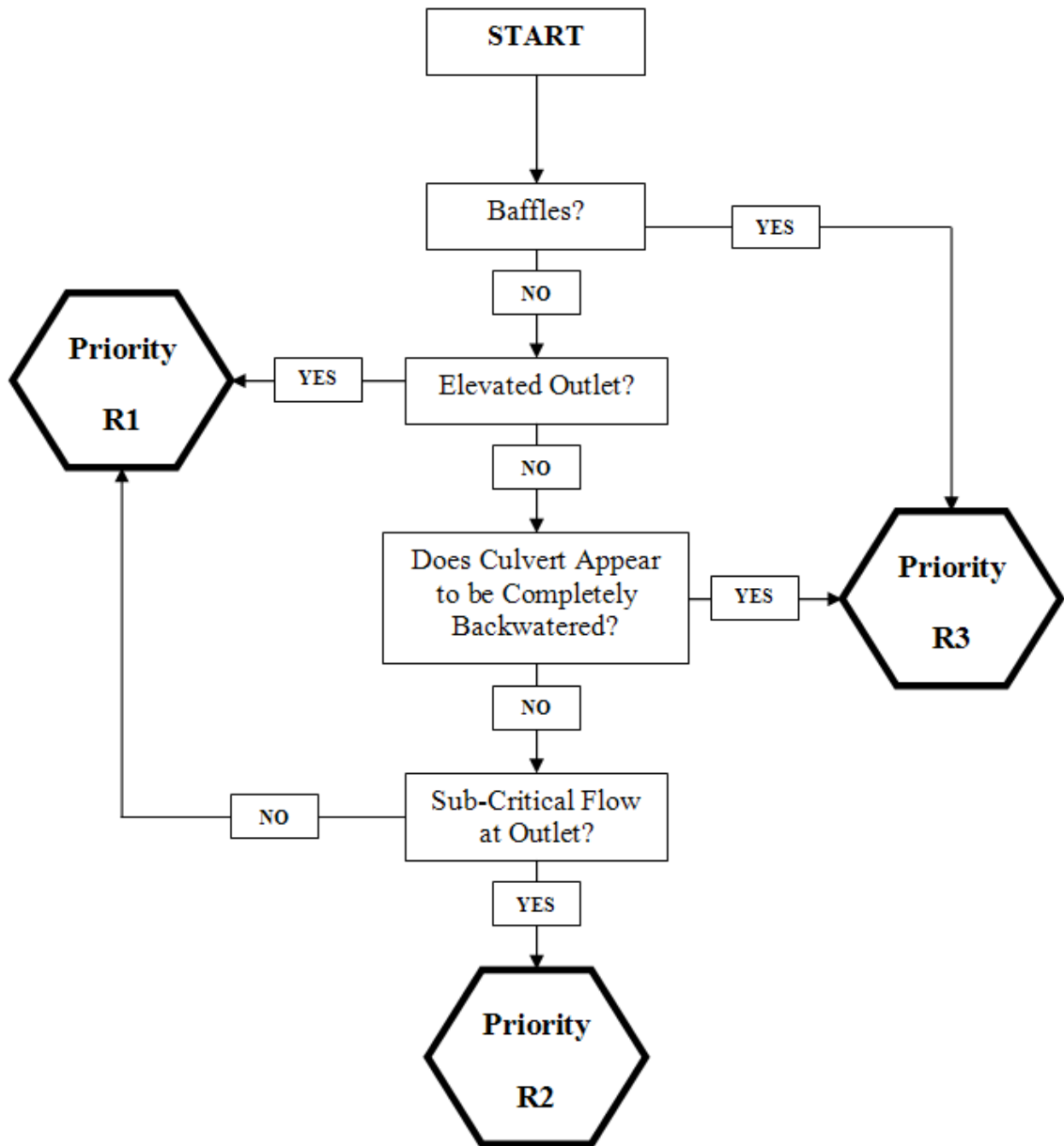

Figure 3-7: Hydraulic Filter Used With the Hydraulic Evaluation

Overlapping the culvert watershed with the UDWR tes_20080220.shp file correlates adjoining fish habitat polygons and the generated culvert watershed polygon. The

tes_20080220.shp file attribute table can then be queried for the number and species type of identified listed/threatened fish species in the watershed. This data can then be input as culvert attributes in the UDOT_culverts.shp file. Fish species and their threatened status are located on the UDWR Sensitive Species List (SSL) in figure 3-8. The UDWR SSL including its introduction is also found in Appendix A.

The corresponding LSI is calculated:

$$LSI = n_1(2) + n_2(1) \quad (3-1)$$

where:

n_1 = Number of federally endangered/threatened species in watershed

n_2 = Number of Utah conservation/concern species in watershed

The LSI has been weighted according to developed UDOT fish passage strategy of delisting endangered fishes in Utah. Federally endangered/threatened species are those which have a “listed” status and receive federal protection until they meet certain sustainable population criteria. Utah conservation/concern species have not yet been federally listed but have been identified as potentially becoming federally listed. The values used to weight the LSI do not indicate relative worth of the separate species groups but reflect the strategy to be more proactive in delisting federally listed species. The number of federally listed species, the number of Utah conservation/concern species and the LSI are recorded as attributes of culverts in the UDOT_culverts.shp file.

Utah Sensitive Species List

Fishes

Federal Candidate Species
(None)

Federally Threatened Species
Lahontan Cutthroat Trout (introduced) *Oncorhynchus clarkii henshawi*

Federally Endangered Species
Humpback Chub *Gila cypha*
Bonytail *Gila elegans*
Virgin Chub *Gila seminuda*
Colorado Pikeminnow *Ptychocheilus lucius*
Woundfin *Plagopterus argentissimus*
June Sucker *Chasmistes liorus*
Razorback Sucker *Xyrauchen texanus*

Conservation Agreement Species
Bonneville Cutthroat Trout *Oncorhynchus clarkii utah*
Colorado River Cutthroat Trout *Oncorhynchus clarkii pleuriticus*
Virgin spinedace *Lepidomeda mollispinis mollispinis*
Least Chub *Iotichthys phlegethontis*
Roundtail Chub *Gila robusta*
Bluehead Sucker *Catostomus discobolus*
Flannelmouth Sucker *Catostomus latipinnis*

Wildlife Species of Concern
Northern Leatherside Chub *Lepidomeda copei*
Southern Leatherside Chub *Lepidomeda aliciae*
Desert Sucker *Catostomus clarkii*
Yellowstone Cutthroat Trout *Oncorhynchus clarkii bouvieri*
Bear Lake Whitefish *Prosopium abyssicola*
Bonneville Cisco *Prosopium gemmifer*
Bonneville Whitefish *Prosopium spilonotus*
Bear Lake Sculpin *Cottus extensus*

Figure 3-8: List of Fish on UDWR SSL

3.5.6 Habitat Fragmentation Index (HFI)

The HFI is a method of assigning assessment priority value to habitat fragmentation exhibited upstream of culverts, it does not represent the actual/precise fragmentation. This value is suggestive of some characteristic level of habitat fragmentation existing in the watershed upstream of the culvert in culverts per mile. The HFI is calculated:

$$HFI = \frac{c}{s} \quad (3-2)$$

where:

c = Number of road-crossings upstream

s = Miles of channel upstream of culvert

The HFI is used to prioritize those culverts which possess an identical regional priority (R1, R2 or R3) and the same LSI. Culverts in the same watershed may have the same regional priority, and depending on watershed size, the same LSI. In this case photos collected as part of the hydraulic evaluation should be referenced to help determine priority. For those culverts possessing the same LSI the HFI can be used to help determine priority. The HFI provides a fractional value which more finely discriminates culverts possessing the same LSI. Thus, in the case of culverts possessing the same LSI, upstream habitat fragmentation becomes the distinguishing characteristic when determining assessment priority.

3.5.7 Culvert Priority Indicator (CPI)

The CPI is designed to be a one stop shopping indicator used to help professionals and managers prioritize culverts based on data developed in this project in a customized manner. The CPI has been developed to showcase a technique, not a specific method of prioritizing culverts. The CPI created as part of this project contains the number of federally listed species, the number of conservation/concern species and the habitat fragmentation index (HFI). It could also be manipulated to include other data deemed pertinent to prioritizing culverts by UDOT. It allows multiple related data to be obtained through a single query. This can become useful in a multi-agency application of a GIS database. Attribute tables can easily swell to several hundred attributes or more as each agency wants their data input into the database. An attribute table of “indicator values” can be constructed to generalize important data deemed pertinent by all using parties, or can be agency specific.

The CPI developed as part of this project was formatted based on the following constraints/assumptions:

- The max number of federally listed species which could possibly inhabit the same Utah waters is no greater than seven
- The max number of conservation/concern species which could possibly inhabit the same Utah waters is no greater than nine
- It’s also reasonable to assume that values of the HFI will never exceed one culvert per 534 feet (this corresponds to an HFI of 9.9)

Using the previous constraints/assumptions the CPI is calculated in the following manner:

$$CPI = n_1(100) + n_2(10) + LSI \quad (3-3)$$

where:

n_1 = Number of federally listed species

n_2 = Number of Utah conservation/concern species

LSI = Listed Species Index

- The number of federally listed species is located in the hundred place
- The number of Utah conservation/concern species are located in the tens place
- The fractional HFI value is located in the ones place and lower

For example:

1. Federal species located in the watershed is equal to 3
2. Utah conservation/concern species located in the watershed is 2
3. The HFI of the watershed is 9.23 culverts per mile
4. The CPI is equal to 329.23

3.5.8 Fish_passage_calibration.xls

A Microsoft Excel file (figure 3-9) was created in association with the database to:

- Electronically store data collected as part of the culvert assessment research
- Reduce non-essential data stored in UDOT_culverts.shp attribute table
- Facilitate calculation of assessment data used in calibrating culvert hydraulic models

HYDRAULIC MODEL DATA			
Data collected as part of this assessment has been provided to help engineers model hydraulic conditions in culverts using hydraulic modeling software such as HY-8, FishXing and Hec-Ras. Below is an outline of the data available in this worksheet to calibrate these models.			
1 Back calculated Manning's <i>n</i> value for the culvert and downstream channel 2 Location of hydraulic jumps 3 Water depth at Inlet and Outlet 4 Slope of water surface for culvert 5 Velocity at Inlet, Mid-Culvert and Outlet			
	CULVERT		
			Water Surface Depth
			Inlet Mid-Culvert Outlet (ft)
Manning's Coefficient:	1.49	(units: english = 1.49, metric = 1.0)	
Wetted Perimeter:		ft	
Hydraulic Radius:	#DIV/0!	ft	
Slope:		(ft/ft)	
Cross Section Area:		(ft ²)	
Discharge:		(ft ³)	
Manning's <i>n</i> :	#DIV/0!		
			Culvert Velocity
			Inlet Mid-Culvert Outlet (ft/s)
			Culvert Water Surface Slope
			(ft/ft)
	TAILWATER		
Manning's Coefficient:	1.49	(units: english = 1.49, metric = 1.0)	
Wetted Perimeter:		ft	
Hydraulic Radius:	#DIV/0!	ft	
Slope:		(ft/ft)	
Cross Section Area:		(ft ²)	
Discharge:	0.0	(ft ³)	
Manning's <i>n</i> :	#DIV/0!		

Figure 3-9: Fish_passage_calibration.xls File for Storing Fish Passage Assessment Data and Generating Data to Calibrate Hydraulic Software for Further Assessing Culverts

The data contained in the Fish_passage_calibration.xls file is populated from the fish passage assessment (section 4) and is used to calibrate culvert hydraulic modeling software such as FishXing (Love et al. 1999). Calibration has been shown to greatly increase the accuracy of the culvert hydraulic modeling software FishXing in predicting fish passage. As an example 1510 days of non-passage predicted by FishXing was reduced to 173 days of non-passage calibrating FishXing with a known discharge and corresponding water depths (Blank 2006).

Hydraulic model calibration data which can be calculated from the Fish_passage_calibration.xls file follows:

- Back calculate Manning's n value for culvert
- Back calculate Manning's n value for tailwater section of channel
- General location of hydraulic jump
- Water surface slope of culvert for use as culvert energy line slope
- Depth of water at inlet and outlet
- Average velocities of inlet, mid-culvert and outlet

A copy of the database developed as part of this project is found in the data CD accompanying this report.

4 Fish Passage Assessment

4.1 Purpose

Decide how to field assess culverts for fish passage and provide UDOT with a developed protocol of the same.

4.2 Methods

Agencies involved in fish passage have developed culvert assessment procedures to aid them in predicting the ability of target fish to traverse upstream through culverts. Fish passage assessments provide agencies with a local/site deterministic method of classifying a culvert's condition to pass specified fish upstream. These assessments are composed of physical assessment data collected at the culvert site and flow charts called "fish screens". Fish screens are used to evaluate the physical assessment data and predict fish passage status for the culvert in question.

UDOT currently does not have a culvert assessment procedure for evaluating culverts for fish passage. Research into culvert assessment was conducted to provide UDOT with an established agency-wide procedure for assessing the fish passage status of its culverts.

4.3 Data Collection

Research conducted to identify potential culvert assessment procedures was performed by literature review, internet search and agency solicitation. Existing culvert assessment procedures used for fish passage applications were identified for further study using the following set of parameters:

- Application at State or regional level
- Currently used by an agency with established fish passage experience
- Compatible with developed UDOT fish passage strategy of least species and endangered status

Initial research produced five culvert assessment documents found to be useful for UDOT:

1. National Inventory and Assessment Procedure (Clarkin et al. 2003)
2. Maine Road Crossing Survey Manual-Draft E (Abbot 2007)
3. Fish Passage Barrier and Surface Water Diversion Screening Assessment and Prioritization Manual (WDFW 2000)
4. Fish Passage Evaluation at Stream Crossings (Love 2003)
5. Evaluation of a Predictive Model for Upstream Fish Passage Through Culverts (Coffman 2005)

Examples of these several documents are contained in Appendix B.

4.4 Data Evaluation

4.4.1 Physical Assessment Data

Several actions were taken to attain a reliable context for compiling a dependable culvert assessment procedure:

- Develop a spatial context for the assessment procedure
- Evaluate relationship between data needs and time constraints
- Periodically meet with UDOT engineers to discuss and revise the procedure

Spatial context for developing a UDOT culvert assessment procedure was obtained by attending three days of USFS culvert assessment training. The body of research was then reviewed to identify a core set of common procedural and physical data common to both USFS and UDOT needs. From this common set of data a template was created to initialize the UDOT assessment procedure. Subsequent meetings with UDOT engineers tailored the template to meet UDOT needs.

The general body of data compiled to produce the template relates to the following:

- Physical dimensions of the culvert
- Longitudinal profile of upstream/downstream channel and the culvert itself
- Cross sectional profile of the downstream channel at the tailwater control
- General substrate characteristics related to the culvert

The template was then expanded for UDOT to include the following additional data:

- Scour pool data points
- Additional culvert dimension & slope data points
- Hydraulic calibration data points

These data points were added to help UDOT better manage and identify scouring at culverts and provide information for calibrating hydraulic software used in culvert design and assessment. Data associated with calibrating hydraulic software includes:

- Back calculate a Manning's roughness value n for culvert and tailwater
- Identify general location of hydraulic jump occurring within culvert
- Depth of water at inlet and outlet
- Average culvert velocities at inlet, mid-culvert and outlet

Finally, a field verification study was performed on the fish passage assessment procedure developed as part of this project to finalize and validate the procedure. A field study was performed at six culverts to obtain observational fish passage data and compare the study findings to fish passage data determined by the developed fish passage assessment procedure. The field verification study and subsequent comparisons are contained in section 5.

4.4.2 Fish Screens

Fish screens are used to evaluate physical fish passage assessment data and produce a deterministic fish passage status for the culvert in question. Developing new and field-tested fish screens for the developed fish passage assessment fell outside the scope of this project. However, existing fish screens were researched to identify those which may be of use to UDOT. Focus was given to those screens which predict fish passage status of culverts at the functional group scale (i.e. adult salmonid, juvenile or young of year salmonid and mid-water minnows, and benthic fish). After an extensive search only one such set of fish screens was identified; these screens probably represent the only non-salmonid screens currently in use for evaluating the fish passage status of culverts in the nation. Although the current shift in the fish passage paradigm includes providing passage for all fish species, culvert assessment research has been slow to develop tools specific to this emerging demographic (Coffman 2005). Our research also confirmed a lack of developed technology/tools for the fish passage assessment of non-salmonid species.

Under the direction of Dr. Mark Hudy, Joseph Coffman, completed work producing fish screens for functional groups of fishes categorized by size, shape and expected similar swim speed physiology (Coffman 2005). These screens were developed specifically to assess the fish passage of functional groups at culverts during base flow or “low flow” conditions. This methodology mirrors the approach adopted in the UDOT fish passage strategy. The fish screens provide passage data for salmonids as well as non-salmonids. Although only one set of fish screens were identified, the Coffman fish screens met our criteria of being currently in use by an agency with established fish

passage experience. Since 2005 the USFS Southern Region (TX, OK, AR, KY, TN, MS, AL, GA, FL, LA, VA, SC, and NC) has used the Coffman fish screens to assess fish passage for the several function groups at their culverts (Coffman et al. 2005).

The strength of the Coffman fish screens is derived from the extensive review and compilation of fish data used to develop the initial screens. The initial screens were developed from data obtained during a comprehensive literature review of journal publications, technical reports, and state and federal agency documents containing relevant data on burst, sustained, and prolonged swimming speeds at varying flows and depths (Coffman 2005). These data were collected without regard for regional species bias, meaning that data was not collected to be regionally species specific but incorporated comprehensive fish data obtained from all available sources. Based on these data an initial fish screen for each of the following functional groups was created:

- Group A: Adult salmonids
 - Salmonids: Trout
- Group B: Young of year (YOY) salmonids & cyprinidae
 - Cyprinidae: Minnows
- Group C: Benthic
 - Cottidae: Sculpins
 - Percidae: Darters

4.5 Fish Passage Assessment Format

The fish passage assessment field data sheet (figure 4-1) contains nine main tasks:

1. Site Information
2. Photos
3. Culvert data
4. Substrate data
5. Longitudinal Survey data
6. Field calculations
7. Culvert Fish Passage Status & Fish Screens
8. Hydraulic calibration
9. Site Sketch

The fish screen in figure 4-2 derives a culvert's fish passage status for the adult salmonid functional group. After the main data are collected from the fish passage assessment the data is used to populate the fish screen flow chart. The culvert is first evaluated for conditions which are assumed will allow the passage of all fish. If substrate is present throughout the entire culvert length the assumption is that the culvert adequately mimics the natural hydraulics of the stream and therefore fish can pass unimpeded through the culvert (Green). If the culvert is completely backwatered the assumption is that all fish can pass unimpeded through the culvert due to the presence of sub-critical flow throughout the entire length of the culvert. If these conditions do not exist the culvert is next evaluated with respect to both the outlet and the downstream tailwater control elevations. If the culvert outlet invert is higher in elevation the culvert is

considered perched. If this elevation differential is greater than two feet for adult salmonids the culvert is considered to be a total barrier to passage of adult salmonids and therefore impassable (Red). Next the culvert slope is evaluated. A threshold value of 7.0 % indicates the cutoff mark for passage or non-passage of adult salmonids. If the culvert slope is less than 7.0 % then the culvert is evaluated further. The next phase of the fish screen evaluates the culvert's slope/length product. The slope (in %) is multiplied by the culvert's length. This product is then evaluated for passage (Green), unknown passage (Grey), and non-passage (Red). Unknown passage indicates the culvert requires an intermediate filter to further evaluate the fish passage status of the culvert. The intermediate filter in this case is the USFS fish passage modeling software FishXing (Love et al. 1999).

Baffles may or may not require specialized and sophisticated methods to assess their fish passage status. If such a sophisticated method is required radio telemetry, mark and recapture or culvert hydraulic software capable of modeling rapidly varying flow should be utilized to perform the assessment.

A copy of the fish passage assessment procedure and accompanying fish screens developed for UDOT is contained in Appendix D.

FISH PASSAGE ASSESSMENT FIELD DATA SHEET

Surveyor Names: _____ Field Date: ____/____/____

SITE

UDOT Region: _____ Route #: _____ Milepost #: _____ Stream Name: _____

GPS: (Lat): _____ (Long): _____ Coordinate System: _____ Units: _____

PHOTOS: Provide Photo #'s, Locations, and Shot Orientation in Sketch

- (1) Embankment Looking Upstream (2) Embankment Looking Downstream
 (3) Looking at Outlet (4) Internal Culvert Structures (5) Slope Break in Culvert (6) Looking at Inlet
 (7) Instream Structures (8) Bank Stabilization Structures (9) Local Erosion (10) Local Failures
 (11) Other: _____

CULVERT DATA:

Physical Length: _____ (ft) Rise: _____ (ft) Span: _____ (ft) Diameter: _____ (ft)

Scour width: _____ (ft) Scour length: _____ (ft)

Corrugation (height): _____ (in.) (width): _____ (in.)

Material: Steel Aluminum Plastic Concrete Other: _____

Shape: Box Circular Pipe Pipe-arch (Squash Pipe) Horizontal Ellipse Arch Arch Box

Roughness: Smooth Corrugated Annular Corrugated Spiral Plated Paved Baffles Slope Breaks

Inlet: Projected Mitered Headwall Wingwall (10-30 Deg) Wingwall (30-70 Deg) Apron Embedded

Inlet Edge Conditions: Grooved Edge Square Edge Beveled Edge

Outlet: At stream grade Perched Cascade Riprap Freefall Embedded Apron

Hydraulic Jump: Absent Present

Hydraulic Jump Location: Inlet Outlet Upper 3rd Middle 3rd Lower 3rd

SUBSTRATE DATA: Provide Substrate Characteristics and Geometry in Sketch

Condition: Absent Continuous Single Patch Patchy

Inlet: Absent Present Outlet: Absent Present

Observed Size: Boulders Cobble Gravel Sand Fines

Notes _____

Figure 4-1: Page 1 of Fish Passage Assessment Field Data Sheet Used to Collect Physical Culvert Data. The Entire Document is Found in Appendix D

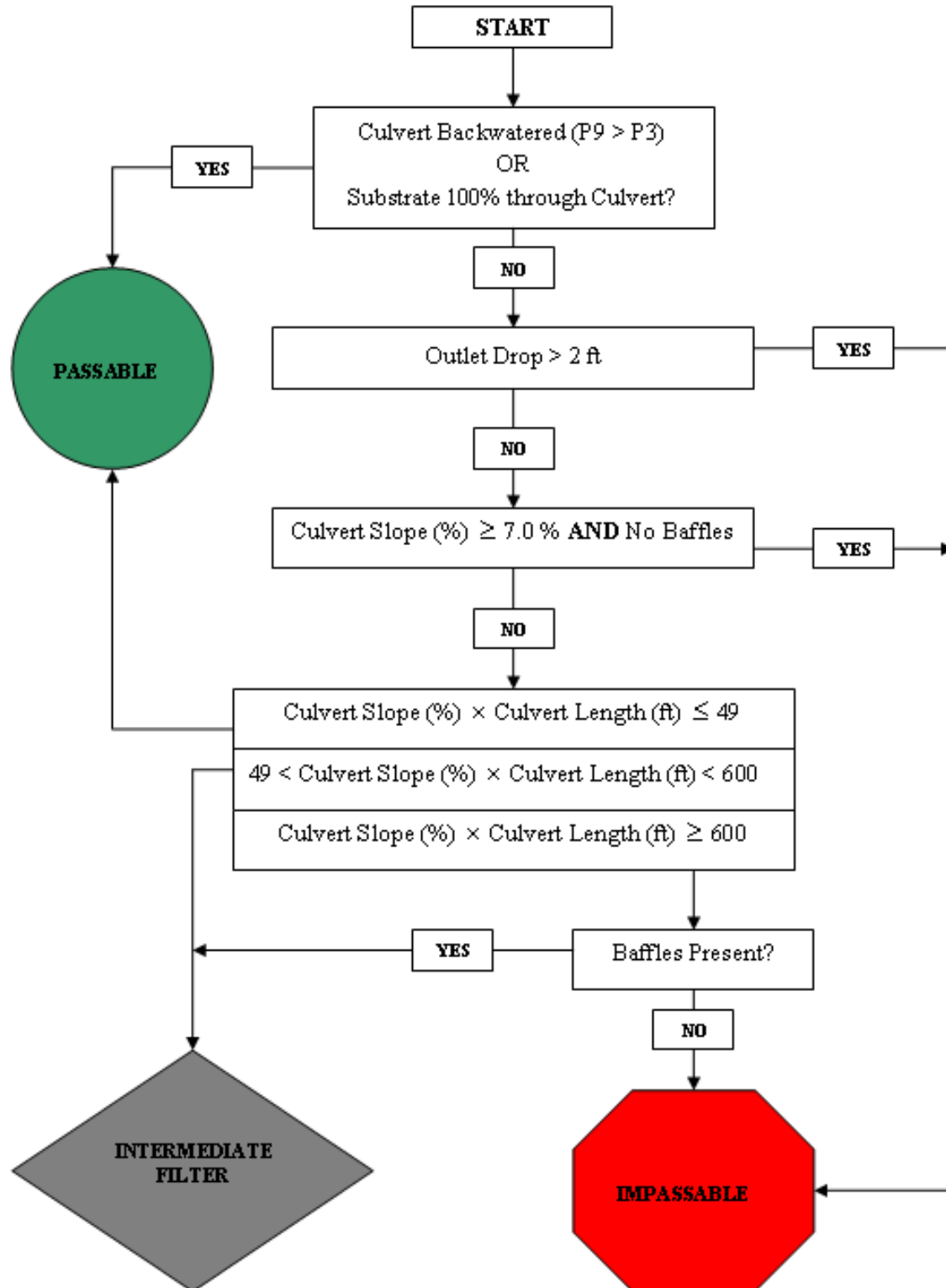

Figure 4-2: UDOT YOY Salmonid & Cyprinidae Fish Screen Used to Derive Fish Passage Status of This Functional Group Using Physical Data Collected From a Fish Passage Assessment (Modified Coffman 2005). All Fish Screens Are Located in Appendix D

5 Assessment Training

5.1 Methods

Proper training for performing culvert assessment procedures is vital for correctly conducting a culvert assessment. Typical training procedures provide hands on and classroom instruction for field personnel in the correct procedure for collecting data. Training should provide enough information for all to safely and efficiently perform the selected culvert assessment method. The UDOT Culvert Assessment Training Manual (CATM) has been developed to train UDOT employees and volunteers on the correct methods of performing the hydraulic and fish passage assessment procedures developed as part of this project.

5.2 Data Collection

Research conducted to identify potential assessment training methods for evaluating fish passage at culverts was performed by literature review, internet search, and agency solicitation, as well as experience gleaned from performing culvert assessments as part of the assessment research.

Existing culvert assessment training procedures used for fish passage applications were identified for further study using the following set of parameters:

- Currently used by an agency with established fish passage experience
- Compatible with developed UDOT fish passage strategy

Of the several procedures used for training on evaluating fish passage at culverts, two were found to be useful for UDOT:

1. National Inventory and Assessment Procedure (Clarkin et al. 2003)
2. FishXing: “A Tutorial on Field Procedures for Inventory and Assessment of Road-Stream Crossings for Aquatic Organism Passage” (USFS 2008)

These resources may be accessed on the Internet at the following web addresses:

- National Inventory and Assessment Procedure:
<http://www.stream.fs.fed.us/publications/PDFs/NIAP.pdf>
- FishXing Tutorial: http://www.fs.fed.us/pnw/pep/PEP_inventory.html?x=1

5.3 Data Evaluation

Information for our procedure was developed in part from the training procedures introduced in section 5.2 as well as from experience drawn from the development and testing of the fish passage assessment procedure.

5.4 Results

As part of the project a culvert assessment training manual was created. The UDOT Culvert Assessment Training Manual (CATM) contains information to train

UDOT employees and volunteers on the several developed prioritization assessment procedures:

- Hydraulic assessment (section 3)
- Fish passage assessment (section 4)

The CATM has been formatted to the same format as this report. It contains its own table of contents, list of figures and tables and related appendices. In an effort to reduce data duplication the reader is referred to the CATM for comprehensive information regarding training on and descriptions of both the hydraulic and fish passage assessment procedures.

6 Field Verification of the Fish Passage Assessment

6.1 Methods

The fish passage assessment is completed using physical data collected at the culvert site and flow charts called “fish screens”. Fish screens are used to evaluate the physical culvert data with respect to fish swimming and leaping abilities to predict fish passage status for the culvert in question. Using fish screens, assessors can predict the culvert’s ability, or lack thereof, to pass fish upstream.

Field verification of the fish passage assessment procedure was performed. Field validation was conducted to compare empirical fish passage data obtained at six UDOT culverts vs. the fish passage status predicted by a fish passage assessment. Empirical data came from a mark and recapture study on fish populations upstream and downstream of the culverts. The field verification study is broken down into four phases:

1. Phase one: Choose culvert sites for performing mark and recapture study
2. Phase two: Collect and mark distinct upstream and downstream fish populations from culverts
3. Phase three: Perform fish passage assessment with developed protocol on all culverts incorporated in the mark and recapture study

4. Phase four: Recapture and identify marked individual specimens as moving upstream through culverts

The duration of the study covered the ascending and descending arms of the spring hydrograph to include the peak. Fish were collected and marked prior to spring runoff. Fish were recaptured after spring runoff had subsided and the streams had returned to a generally associated base flow. The study was designed in this manner to take advantage of increased fish movement due to an increase in discharge (Albanese et al. 2004) as well as the spring seasonal effect of increasing fish movement (Hilderbrand 2000). Table 6-1 details mark and recapture dates for each culvert at the several field validation sites.

Table 6-1: Mark and Recapture Dates for Field Validation Sites

MARK AND RECAPTURE DATES		
CULVERT	Mark	Recapture
Diamond Fork #1	7-Apr-07	13-Oct-07
Diamond Fork #2	7-Apr-07	13-Oct-07
Salina Creek	12-Apr-07	14-Aug-07
Solider Creek	24-Mar-07	6-Aug-07
Daniel's Creek #1	21-May-07	9-Aug-07
Daniel's Creek #2	21-May-07	13-Aug-07

6.2 Data Collection

6.2.1 Site Selection

In collaboration with the UDOT, UDWR and USFS personnel, culverts chosen were based on:

- Passing least species, or weakest swimming/leaper in watershed
- Determining passage for a functional group of fishes
- Being located in drainages possessing adequate species diversity
- Sample set of culverts should be perceptually chosen to incorporate passage status of passing, not passing and unknown passing
- Varying sizes

Using the above culvert criteria we were able to develop the following set of target characteristics for our culverts:

- Generally located on larger streams
- Locate one sample on smaller stream
- Locate in watersheds with adequate fish diversity
- One sample possessing perch or negative residual outlet depth
- One sample containing baffles
- One sample of inlet control

The investigation phase consisted of traveling statewide (figure 6-1), to identify potential culverts for use in the field validation test. Culverts meeting our established criteria were screened to evaluate species diversity and the presence of threatened fishes. Adequate species diversity in the culvert watershed was essential to the study to include the evaluation of fish passage at the functional group scale.

Also of importance was the absence of threatened fishes in the immediate watershed. Due to the protected status of threatened fishes their presence in the watershed prohibited the use of these culverts in the study.

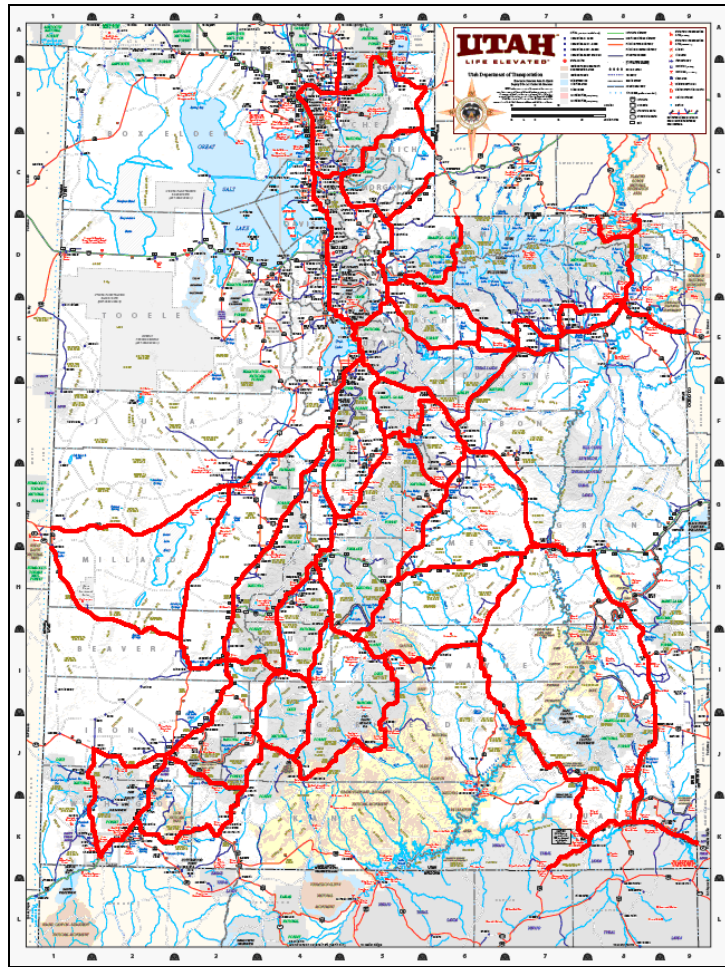

Figure 6-1: Travel Routes Taken to Find Appropriate Culvert Sites for Field Verification Study

The following sites were selected to use in the field verification study (figure 6-2):

- Soldier Creek at HWY 89 (Spanish Fork Canyon near Spanish Fork, Utah)
- Diamond Fork River at HWY 6 (Spanish Fork Canyon near Spanish Fork, Utah)
- Salina Creek at HWY 70 (Approximately 15 miles east of Salina, Utah)
- Daniel’s Creek at HWY 40 (Approximately 12 miles South East of Heber, Utah)

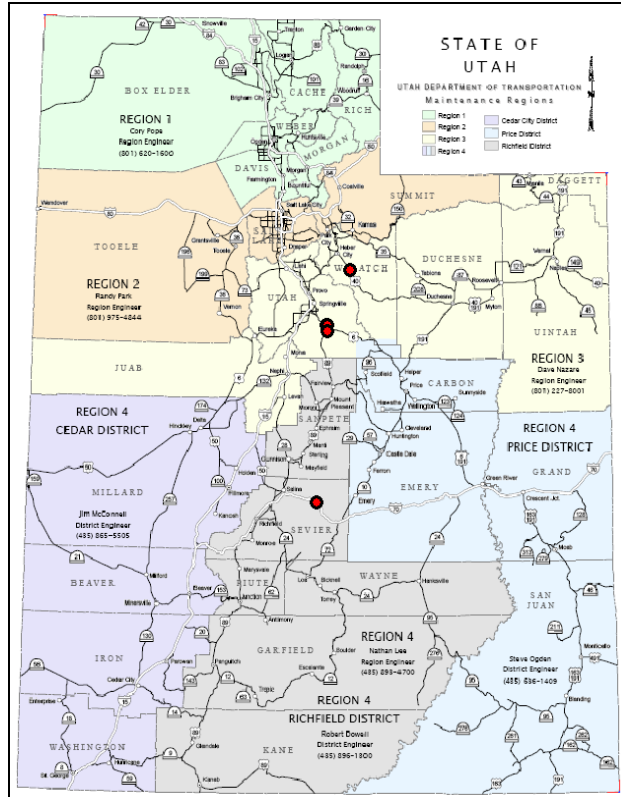

Figure 6-2: Locations of the Four Field Sites Used in the Field Verification Study

Two culverts each were sampled at the Diamond Fork and Daniel’s Creek sites respectively. This was due to their close proximity to each other. For all other sites one culvert was sampled. Downstream culverts at the Diamond Fork and Daniel’s Creek sites

are identified as culvert #1 and the upstream culverts at each site are identified as culvert #2. The general characteristics of each of the six culverts are summarized in table 6-2 and each culvert outlet and inlet is illustrated in figures 6-3 through 6-14.

Table 6-2: General Culvert Dimensions of Culverts at Field Verification Sites

GENERAL CULVERT DATA				
SITE	Span (ft)	Length (ft)	Slope (%)	Inlet/Outlet Control
Diamond Fork #1	12	164	0.60	Fish Baffles
Diamond Fork #2	12	590	0.74	Fish Baffles
Salina Creek	14.5	255	0.56	Inlet
Solider Creek	17.5	600	0.27	Outlet
Daniel's Creek #1	6.5	90	0.83	Outlet
Daniel's Creek #2	6.5	94	1.69	Inlet



Figure 6-3: Diamond Fork Culvert #1 Outlet (Diamond Fork Field Verification Site)



Figure 6-4: Diamond Fork Culvert #1 Inlet (Diamond Fork Field Verification Site)



Figure 6-5: Diamond Fork Culvert #2 Outlet (Diamond Fork Field Verification Site)



Figure 6-6: Diamond Fork Culvert #2 Inlet (Diamond Fork Field Verification Site)



Figure 6-7: Salina Creek Culvert Outlet (Salina Creek Field Verification Site)



Figure 6-8: Salina Creek Culvert Inlet (Salina Creek Field Verification Site)



Figure 6-9: Soldier Creek Culvert Outlet (Soldier Creek Field Verification Site)



Figure 6-10: Soldier Creek Culvert Inlet (Soldier Creek Field Verification Site)



Figure 6-11: Daniel's Creek Culvert #1 Outlet (Daniels Creek Field Verification Site)



Figure 6-12: Daniel's Creek Culvert #1 Inlet (Daniels Creek Field Verification Site)



Figure 6-13: Daniel's Creek Culvert #2 Outlet (Daniels Creek Field Verification Site)



Figure 6-14: Daniel's Creek Culvert #2 Inlet (Daniels Creek Field Verification Site)

6.2.2 Mark

Data were collected using electro-shock methods for obtaining fish specimens at selected culvert sites. Specimens were collected by hand and block nets downstream and upstream from culverts. Standard length was recorded for every collected specimen. Upstream and downstream populations of fish were identified by injecting a visible color coded tag just beneath the surface of transparent areas of skin. Different colors were used to differentiate upstream and downstream populations. Specimens were subsequently released back into the stream respective to their upstream or downstream collection site. Upstream populations were placed 20 meters upstream from the culvert inlet and downstream populations were placed 10 meters downstream from the culvert outlet.

Photos illustrating the collection (figure 6-15 and 6-16), measurement (figure 6-17), tagging (figure 6-18), and tag location (figures 6-19 and 6-20) of fish specimens follow.



Figure 6-15: Collecting Fish Specimens by Electro-shocking and Netting Methods Downstream of Salina Creek Culvert



Figure 6-16: Specimens Collected in Block Net Downstream of Salina Creek Culvert



Figure 6-17: Measuring Standard Length of Bonneville Cutthroat Trout at Salina Creek Site



Figure 6-18: Tagging a Leatherside Chub Near the Base of the Caudal Fin at the Salina Creek Site



Figure 6-19: Yellow Subcutaneous Epoxy Tag Near the Base of the Caudal Fin



Figure 6-20: Yellow Subcutaneous Epoxy Tag Anterior and Posterior of Fish Eye

Data collected during this phase of the field verification study is found in Appendix C.

6.2.3 Fish Passage Assessment

After the collection and marking phase of the mark and recapture study was completed a fish passage assessment was performed on each of the six culverts in the field verification study. Table 6-3 summarizes the fish passage assessment findings predicted by the Coffman fish screens.

Data collected as part of the fish passage assessment performed on each of the culverts are found in Appendix C.

Table 6-3: Fish Passage Prediction Produced by Coffman Fish Screens

COFFMAN FISH SCREEN PREDICTIONS			
CULVERT	AS	YS/C	B
Diamond Fork #1	INDETERMINATE	INDETERMINATE	IMPASSABLE
Diamond Fork #2	INDETERMINATE	INDETERMINATE	INDETERMINATE
Salina Creek	IMPASSABLE	IMPASSABLE	IMPASSABLE
Solider Creek	PASSABLE	PASSABLE	PASSABLE
Daniel's Creek #1	PASSABLE	PASSABLE	PASSABLE
Daniel's Creek #2	INDETERMINATE	INDETERMINATE	IMPASSABLE
* AS = Adult Salmonid YS/C = Young of Year Salmonid & Cyprinidae B = Benthic			

6.2.4 Recapture

Culverts at the original six field verification sites were revisited and upstream and downstream fish specimens were collected using electro-shocking and netting methods described previously. Collected specimens were inspected for previous injection of color coded tag. Fish were recognized as original upstream or downstream populations and upstream movement of originally identified downstream specimens was evaluated based on tag color. Table 6-4 summarizes the actual observation of functional group species moving completely upstream through the culvert from the downstream population.

Table 6-4: Observations of Downstream Marked Fish Passing Completely Through the Culvert in the Upstream Direction

MARK & RECAPTURE CULVERT PASSAGE OBSERVATIONS			
CULVERT	AS	YS/C	B
Diamond Fork #1	NO	NO	NO
Diamond Fork #2	NO	NM	NO
Salina Creek	NO	NO	O
Solider Creek	NO	O	O
Daniel's Creek #1	O	NO	O
Daniel's Creek #2	O	NO	O
* AS = Adult Salmonid YS/C = Young of Year Salmonid & Cyprinidae B = Benthic O = Observed NM = Not Marked NO = Not Observed			

Representatives of all functional groups were collected and marked at each culvert site. The only exception is the Diamond Fork # 2 culvert. Although young of year salmonid and cyprinidae were present in the immediate watershed, none were collected and marked. Data collected as part of the recapture at each of the culverts are found in Appendix C.

6.3 Data Evaluation

The Diamond Fork #1 culvert possessed a slope of 0.60 % and Diamond Fork #2 culvert possessed a slope of 0.69%. Both culverts possessed fish baffles to facilitate the upstream passage of fish. Both sets of baffles in each culvert were found to have been completely filled in with sediment in several places creating a total barrier to upstream passage for fish utilizing the baffles. No fish were observed moving upstream through either culvert.

The Salina Creek culvert possessed a slope of 0.56 % and a perched outlet of greater than 2 ft with a cascading outlet flow over concrete and riprap. It also possessed a wildlife trail which heavily constricted base flows. The culvert was inlet controlled during the assessment sub-critical flow was absent throughout the entire length of the culvert. One Mountain sucker was observed moving completely upstream through the culvert.

The Soldier Creek culvert possessed a slope of 0.27 % and was completely backwatered. The tailwater control elevation was greater than the culvert inlet invert elevation. The culvert was outlet controlled during the assessment and the culvert possessed sub-critical flow throughout the entire length of the culvert. Four Leatherside

chub, two Mountain sucker, and one Longnose dace were observed moving completely upstream through the culvert.

The Daniel's Creek #1 culvert possessed a slope of 0.83 % and was completely backwatered. The tailwater control elevation was greater than the culvert inlet invert elevation. The culvert was outlet controlled during the assessment and the culvert possessed sub-critical flow the throughout entire length of the culvert. Two Mottled sculpin and four Brown trout were observed moving completely upstream through the culvert.

The Daniel's Creek #2 culvert possessed a slope of 1.69 % and was inlet controlled during the assessment. A hydraulic jump occurred near mid-culvert and the culvert outlet was backwatered. The tailwater control elevation was greater than the culvert outlet invert. Correspondingly sub-critical and critical flow was present simultaneously in the culvert. One Mottled sculpin, two Cutthroat trout, and seven Brown trout were observed moving completely upstream through the culvert.

Table 6-5 summarizes the comparisons made between actual observations of fish passage collected from the field verification study and the fish passage assessments using the Coffman fish screens.

Table 6-5: Coffman Fish Screen Predictions Compared to Observed Fish Passage Data

COFFMAN PREDICTIONS COMPARED TO OBSERVATIONAL DATA			
CULVERT	AS	YS/C	B
Diamond Fork #1	DEFICIENT	DEFICIENT	DEFICIENT
Diamond Fork #2	DEFICIENT	DEFICIENT	DEFICIENT
Salina Creek	DISSIMILAR	DISSIMILAR	DISSIMILAR
Solider Creek	EQUIVALENT	EQUIVALENT	EQUIVALENT
Daniel's Creek #1	EQUIVALENT	EQUIVALENT	EQUIVALENT
Daniel's Creek #2	EQUIVALENT	EQUIVALENT	DISSIMILAR
* AS = Adult Salmonid YS/C = Young of Year Salmonid & Cyprinidae B = Benthic			

When comparing tables 6-3 and 6-4 to table 6-5 you will note that a status of “EQUIVALENT” in table 6-5 has been determined for some functional groups for which there was no observational data confirming upstream passage through a culvert. In these cases a smaller or equivalently sized fish species was observed passing successfully through a culvert and larger species were not observed passing. In these cases we concluded that the culvert was passable for the larger species. This generalization was derived from the positive correlation between the body mass and swimming velocity of fishes (Peters 1983).

Conditions at the Diamond Fork #1 and #2 culverts made comparisons between the observational data and Coffman screens challenging. First, no fish were observed moving through either culvert, yet both possessed fish baffles to facilitate the upstream movement of fish. It was determined later that these baffles had been filled in with



Figure 6-21: Orientation of Baffles in Diamond Fork #2 Culvert (Looking Downstream)



Figure 6-22: Close-up of Sediment Filled Section of Fish Baffles in Diamond Fork #2 Culvert

sediment in several locations creating a complete barrier to fish utilizing the baffles for upstream movement. Not only did the filled in baffles create a barrier but they also caused flow to become constricted causing increased velocities in the adjacent “un-baffled” portion of the culvert (see figures 6-21 and 6-22).

These conditions likely contributed to the absence of observational data at these culverts which hindered the capability of drawing comparisons with predictions derived from the Coffman screens. Second, the Coffman screens do not address the presence of fish baffles and any advantage they may provide to the upstream passage of fish. Our conclusion is that there was insufficient data to make a comparison between observed data and the Coffman screens were deficient in addressing a baffled culvert condition and would require some modification in this regard.

Salina Creek culvert comparisons between the observational data and Coffman screens were also challenging. First the culvert possessed an outlet perch in excess of two feet. Based on leaping ability alone the Coffman screens indicated that no species of fish could circumvent the culvert. Second the culvert contained a wildlife trail which severely constricted flow and increased velocity (see figure 6-23 and 6-24).



Figure 6-23: Salina Creek Culvert Outlet and Wildlife Trail Looking Downstream

Average velocity at base flows was determined to be in excess of 7 ft/s. Even with these unfavorable conditions one Mountain sucker was observed passing successfully through the culvert in the upstream direction.

Based on the observed passage of fish and culvert conditions we conclude that at certain flows some degree of fish passage is possible for mountain sucker and possibly other species. The physical conditions downstream of this culvert influencing the

tailwater height at the outlet probably contribute to the passage of fish at this culvert during higher flows.



Figure 6-24: Salina Creek Outlet and Wildlife Trail Looking Upstream

At higher flows the tailwater reaches a sufficient height to overcome any height barrier that exists for the mountain sucker or creates favorable hydraulics for passage. No data could be located on the leaping ability of mountain sucker. Due to the historic fish passage focus on collecting this type of data for salmonids it's likely that no such data exists for mountain suckers.

Conditions contributing to the passage of this individual are likely a result of the unique relationship between physical culvert attributes and the downstream channel and floodplain. It may also be a compound result of the aforementioned culvert/tailwater relationship and undocumented leaping abilities and/or advantages mountain sucker may

possess over other fish in traversing certain hydraulic conditions. Due to the uniqueness of the situation and the need for fish screens to produce conservative predictions for a large body of culverts we desire that our developed screen derive a fish passage status of impassable for all functional groups at this culvert as was predicted by the Coffman screens.

Based on the observed passage of fish and culvert conditions we conclude that the Soldier Creek and Daniel's Creek #1 culverts both allow some degree of passage for all functional groups. The Coffman screens derived a fish passage status of passable for all functional groups at these culverts.

Based on the observed passage of fish and culvert conditions we conclude that the Daniel's Creek #2 culvert allows some passage for all functional groups. The Coffman screens derived a fish passage status of indeterminate for adult salmonid and YS/C functional groups and a status of impassable for the benthic group. The limiting factor in the Coffman screen predicting an impassable status for the benthic functional group was the culvert slope/length product. The threshold value for deriving an impassable status in benthic fish is approximately equal to or greater than 151 ft. The actual value was 159 ft, just slightly higher than 151 ft. and thus producing an impassable status.

Passage not only occurs in the Coffman screens for a predicted "passable" status but also for a predicted status of "indeterminate". The percent passing is unknown for a passage status of indeterminate but fish passage at some level is considered to be taking place. Due this character of the Coffman screens observing passage of fish and obtaining a correlated predicted status of indeterminate by the screen is considered equivalent. Therefore an equivalent comparison between observed data and the passage status

predicted by Coffman screens for adult salmonids and YS/C functional groups are valid at the Daniel's Creek #2 culvert. Modifications can be made to the benthic Coffman fish screen to calibrate it to the data point we observed for passage of the Mottled sculpin through the Daniel's Creek #2 culvert.

6.3.1 Results

Generally the Coffman screen correctly predicted fish passage. Modifications related to non-equivalent comparisons presented in table 6-5 are as follows:

- Modify culvert assessment procedure to incorporate what measures to take when encountering fish baffles at assessed culverts
- Calibrate Coffman Group C (Benthic) screen to derive a passage status of indeterminate for the observed Daniel's creek #2 benthic status based on modification procedure found in Coffman (2005)

7 Project Summary & Conclusions

Deliverables created as part of this project have been developed to meet the established criteria for UDOT fish passage strategy expectations and to fulfill project objectives.

Project objectives were to:

1. Develop a strategy for prioritizing culverts for fish passage
2. Create a pilot assessment database for UDOT to build upon based upon assessment results
3. Determine an appropriate assessment protocol for Utah and test it in the field

Deliverables and the associated project objectives they fulfill are as follows:

1. Fish Passage Database and associated tools
 - Develop a strategy for prioritizing culverts for fish passage
 - Create a pilot assessment database for UDOT to build upon based upon assessment results
2. Fish Passage Assessment
 - Determine an appropriate assessment protocol for Utah and test it in the field
3. Culvert Assessment Training Manual
 - Determine an appropriate assessment protocol for Utah and test it in the field

We conclude that:

1. The Fish Passage Database and associated tools

- Provide a useful systematic method of prioritizing culverts at the state and regional level for fish passage assessment
- Provides prioritization based on fish endangered status and habitat fragmentation
- Stores appropriate data associated with managing UDOT culverts for fish passage
- Provides a format to expand or incorporate existing database functions into future UDOT GIS databases

2. The Fish Passage Assessment

- Is a validated and appropriate protocol for assessing the fish passage status of UDOT culverts
- Provides evaluation of fish passage based on functional group passage
- Incorporates data to appropriately calibrate hydraulic culvert modeling software

3. The Culvert Assessment Training Manual (CATM)

- Provides sufficient background and information to train individuals on culvert assessments developed for UDOT

8 Recommendations

8.1 Fish Passage Prioritization & Assessment Implementation Plan

A conceptual framework was created to establish critical progression for prioritizing culverts for fish passage utilizing the project deliverables. This framework has been developed to meet the established criteria for UDOT fish passage strategy expectations. The implementation and execution of the several project deliverables as they pertain to the developed UDOT fish passage strategy has been termed the UDOT Fish Passage Prioritization & Assessment Implementation Plan (FPAIP) (figure 8-1).

The FPAIP is initiated by entering the GIS database and selecting the desired Utah region for assessment using the Utah_CAPI.shp file. Regions are selected according to state priority codes S1 through S4. S1 receives the highest priority and S4 receives the lowest priority.

Regions retaining a S1 prioritization should be investigated first. Using topo and aerial images and route, stream, road-crossing data, and any other data UDOT believes would benefit the procedure, the selected region is evaluated for potential culvert sites. Sites which represent a reasonable expectation of being a culvert and possessing sufficient water to support a viable population of fish are generated on a map or list.

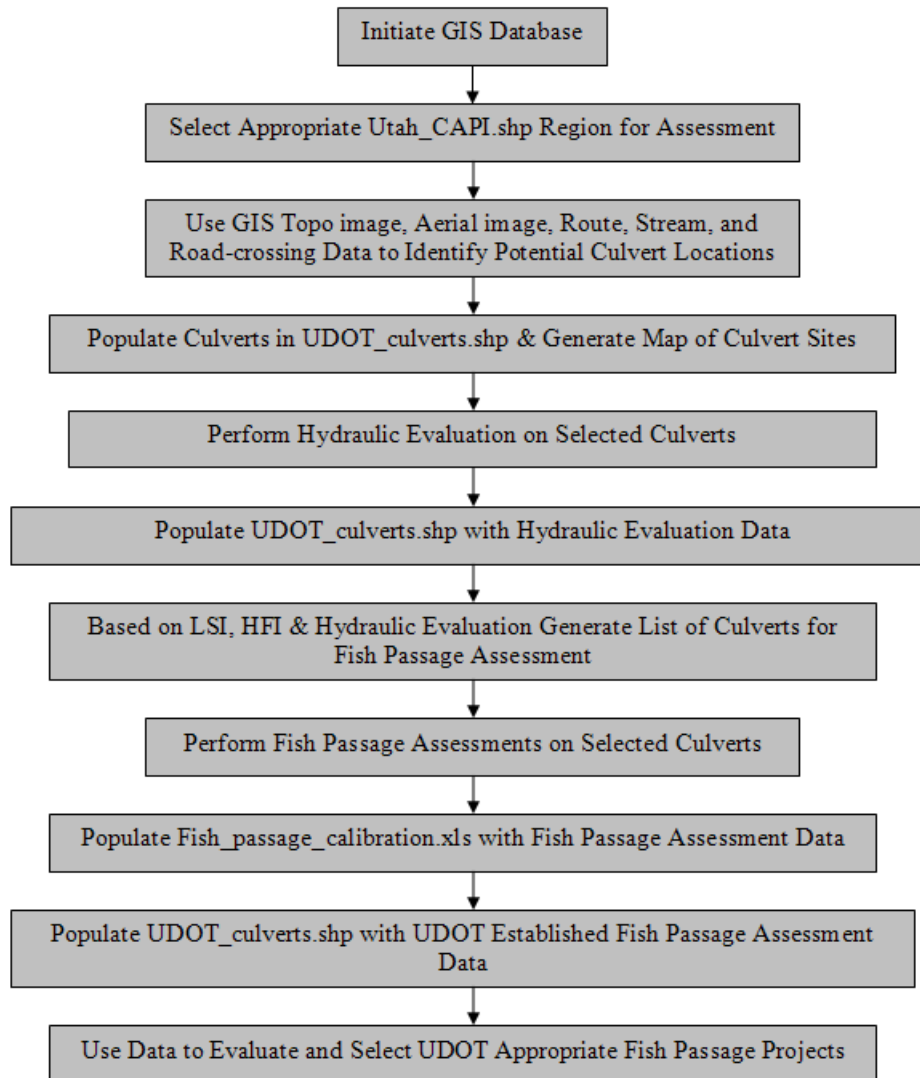

Figure 8-1: Flow Chart Outlining the FPAIP

Trained field technicians perform a hydraulic evaluation on all listed culverts. All data points from the evaluation are populated on an erasable marker board which held and photographed while taking photographs of the inlet and outlet. A comprehensive outline of the hydraulic evaluation is contained in Appendix D.

Data collected from the hydraulic evaluation is populated to the UDOT_culverts.shp file. Evaluation photographs are linked to each corresponding

individual culvert evaluated. The hydraulic evaluation prioritizes culverts regionally. Culverts are selected according to regional priority codes R1 through R3. R1 receives the highest priority and R3 receives the lowest priority.

Using fish distribution, stream and route data in GIS the LSI, HFI, and CPI are generated for those culverts which have had a hydraulic evaluation performed. This value is stored as a culvert attribute for corresponding culverts in the UDOT_culverts.shp file.

Culverts are grouped based on regional priority values (R1, R2, & R3). R1 priority culverts are further prioritized by LSI. Culverts possessing the same regional and LSI prioritization values are further prioritized by the HFI. Culverts possessing a R1 prioritization as well as the highest LSI value should be investigated first (the HFI ranking those culverts possessing the same LSI). These culverts are populated to a list for performing a comprehensive fish passage assessment. Fish passage assessment data provides a deterministic passage status for the functional groups of fish:

- Adult salmonid
- Young of year salmonid and cyprinidae
- Benthic

A comprehensive outline of the fish passage assessment is contained in Appendix D. Fish passage assessment data is then populated to the UDOT_culverts.shp file as well as the Fish_passage_calibratoin.xls file if necessary (when a passage status of GREY w/o baffles is obtained).

At this point the FPAIP functionally ends; prioritization is no longer the controlling factor. Culverts can now be selected for replacement or retrofit for fish passage. Due to budgetary, political, legal, and other mitigating circumstances it lies outside the scope of our project to determine which fish passage projects may possess both the opportunity and agency ability to complete. However, culverts can be selected for further prioritized based on the number of functional groups the culvert successfully passes or needs to pass. Culverts representing the highest priority should be identified and shared with other state agencies involved in fish passage.

8.2 GIS Database Context

Past culvert management and maintenance databases have relied heavily on an individual point resource management approach. This technique allows agencies to track and manage culverts as single unconnected resources with a spatial scale composed of the immediate physical area of the culvert. As culvert management emphasis has changed to incorporate the growing area of fish passage, the technology to store, track and manage fish passage data has been slow to respond to the needs of the accompanying paradigm shift. As the UDOT Fish Passage GIS Database was developed we drew the following conclusions as to the scope of its successful use:

- Management of culverts at the watershed scale
- Multi-agency communication, cooperation, and planning

Current advanced fish passage database technologies manage culverts using management tools which not only include the former spatial scale but also incorporate a

watershed spatial scale. At the watershed scale, aquatic habitat restoration, such as fish passage, focuses and concentrates on restoring ecosystem functions rather than simple point resource management. This watershed focus ensures restorative efforts are organized and performed at a scale which is most beneficial for protecting and enhancing the diverse aquatic functions the many biotic resources in the watershed rely upon (Bohn 2002). The relative number of ecosystem functions, the number of agencies with controlling interest over those functions, and the overlapping management boundaries creates a dynamic where no one agency has authorization or resources to restore all or many of the eco-system functions at the watershed scale. Therefore, successful management of culverts for fish passage must include management on a watershed scale and must include cooperating with other agencies and private entities which manage and own overlapping or interconnected ecosystem functions and natural resources within the same watershed.

8.3 Recommended Automation for GIS Database

When populating a culvert to the UDOT_culverts.shp file automate the following:

- Culvert ID number “CulId”
- Populating the corresponding Utah_CAPI.shp priority value (S1, S2, S3, or S4) as a culvert attribute “StatePri”
- Watershed delineation using culvert as outlet control point and store in a corresponding shapefile created specifically for culvert watersheds
- Cumulative miles of upstream channel “CumStr”
- Number of upstream road-crossings or culverts “NumCross”

- Number of federally listed species in watershed “FedSpecie”
- Number of state listed species in watershed “StSpecie”
- Calculate the LSI
- Calculate the HFI
- Calculate the CPI
- Create a Fish_passage_calibration.xls file and hyperlink it to the culvert point
- Populate the corresponding stream name as a culvert attribute

8.4 GIS Database Resources

Currently UDOT is partnering with the Utah Automated Geographic Reference Center (AGRC) to create an interagency GIS database containing culvert fish passage data which can be viewed and populated with data by select federal, state and private organizations.

Through our research several key relationships have been made with ADFG employees working with the FPID. Although permission to obtain a copy of the ADFG database has not been expressly granted, all prior communications with the ADFG indicate that the agency is more than willing to cooperate with UDOT/AGRC in this matter. Additional contact and communication with the ADFG will be needed to develop a relationship such that the ADFG gives its consent for UDOT/AGRC to obtain a copy of the FPID for UDOT/AGRC use. Currently the FPID is not well designed for producing functioning copies to outside sources. The ADFG is in the process of simplifying their GIS database, such that producing functioning copies via CD to other agencies in the future can be feasible. Simultaneously the ADFG is seeking to streamline data collection

and upload to make the database more efficient and user friendly. This situation presents an opportunity for UDOT/AGRC to joint venture with the ADFG. Possible methods of contribution could include technical recourses and/or monetary funding. Another option is that ADFG may not require such contributions and may make the database available to UDOT at no charge once completion of the redesign process is finished.

8.5 Culvert Assessment Resources

Culvert assessments may be provided by volunteer help at no cost to UDOT. The magnetizing environmental ideologies surrounding fish passage make it a highly visible and attractive volunteer project for communities and organizations who value natural resources. Agencies coordinating volunteer efforts such as the following provide direct and often free assistance to entities seeking to perform assessments/projects dealing with natural resources:

- Utah Fish & Wildlife Management Assistance Office
 - Phone: (435) 789-0351
 - Email: UtahFishandWildlife@fws.gov
 - Web Site: www.fws.gov/utahfishandwildlife/index.htm
- Utah Council of Trout Unlimited
 - Council Chair: Chris Thomas
 - Phone: (435)-797-3753
 - Email: chris.thomas@usu.edu
 - Web Site: <http://www.tuutah.org/>
- Utah Chapter Sportsmen for Fish and Wildlife

- Chairman: John Bair
- Phone: (801)-472-0552
- Email: bairauctions@yahoo.com
- Web Site: <http://www.sfwsfh.org/utah.cfm>
- Utah Department of Wildlife Resources Dedicated Hunter Program
 - Central Region: Rhianna Christopher
 - Phone: (801)-538-4710
 - Email: RhiannaChristopher@utah.gov
 - Web Site: <http://wildlife.utah.gov/dh/>

Additionally the following local resources might be initialized through/by UDOT:

- Boy Scouts of America Eagle Project
- Local Adopt a Culvert Programs
 - Schools and local clubs

These organizations only represent some of the possible volunteer resources which are available within the state of Utah. Additional time and consideration should be given to identifying those resources and drawing upon them if possible.

8.6 Implementations Beyond UDOT Scope

8.6.1 Calibrating Hydraulic Software

- Current fish passage procedures give little to no consideration for calibrating culvert hydraulic software
- Calibration can greatly increase the accuracy of fish passage assessment models

- Conservative estimates are good for design but less so for assessments
 - Increase cost due to culvert retrofit or replacement when not really needed

8.6.2 Statewide Culvert Prioritization Methods

- Systematic statewide fish passage culvert prioritization techniques for are lacking
- States are only now beginning to address fish passage on a state scale

8.6.3 Hydraulic Evaluation and Filter

- Agencies struggle with assessing culverts
 - How many culverts can we assess?
 - How in depth should the assessment be?
- Hydraulic Evaluation and Filter could be used as a very rough fish passage assessment
 - Simple protocol construction
 - Quick and easy to perform
 - More bang for budget dollars
 - Increased number of culverts assessed/visited
 - Reduced cost
 - Decrease number of comprehensive assessments performed by eliminating obvious barriers from comprehensive assessment pool
 - Easily modified to meet specific needs of agency

References

- Abbot, A. (2007). *Maine Road Crossing Survey Manual-Draft E*, Gulf of Maine Coastal Program, U.S. Fish and Wildlife Service, Falmouth, MN.
- ADFG (2008). Fish Passage Improvement Program Web Site: “Fish Passage Inventory Database.” Retrieved July 15, 2008 from http://www.sf.adfg.state.ak.us/SARR/Fishpassage/FP_mapping.cfm
- Albanese, B., Angermeier, P.L., and Dorai-Raj, S., (2004). “Ecological Correlates of Fish Movement in a Network of Virginia Streams”. *Canadian Journal of Fisheries and Aquatic Sciences* 61, 857-869.
- Blank, M., Cahoon, J., Burford, D., McMahon, T., and Stein, O. (2006) “Studies of Fish Passage through Culverts in Montana”, 2005 International Conference on Ecology and Transportation, Center for Transportation and the Environment, North Carolina State University, Raleigh
- Bohn B. A. and Kershner J. L. (2002). “Establishing Aquatic Restoration Priorities Using a Watershed Approach”. *Journal of Environmental Management* 64(4), 355–363.
- CalFish (2008). CalFish Data and Maps Web Site: “California Fish Passage Assessment Database.” Retrieved July 15, 2008 from <http://dnn.calfish.org/calfish2/FishDataandMaps/tabid/87/FishMaps/tabid/88/Default.aspx>
- Clarkin, K., A. Conner, M. J. Furniss, B. Gubernik, M. Love, K. Moynan, and S. Wilson Musser (2003). *National Inventory and Assessment Procedure for Identifying Barriers to Aquatic Organism Passage at Road-stream Crossings*, USDA Forest Service.
- Coffman, J. S. *Evaluation of a Predictive Model for Upstream Fish Passage through Culverts*, Master’s Thesis, James Madison University, 2005.

- Coffman, J. S., Minter, M., Zug, J., Nuckols, D., Roghair, C., and Dolloff, C. A. (2005). *Fish Passage Status of Road Stream Crossings on Selected National Forests in the Southern Region, 2005*, Unpublished File Report, USDA Forest Service, Southern Research Station, Center for Aquatic Technology Transfer, Blacksburg, VA.
- Hilderbrand, R.H., and Kershner, J.L. (2000). "Movement Patterns of Stream-Resident Cutthroat Trout in Beaver Creek, Idaho-Utah". *Transactions of the American Fisheries Society* 129, 1160–1170.
- Love, M., Firor, S., Furniss, M., Gubernick, R., Dunklin, T., and Quarles, R. (1999). FishXing (Version 2.2). Six Rivers National Forest Watershed Interactions Team, USDA Forest Service, San Dimas Technology and Development Center, San Dimas, California. www.stream.fs.fed.us/fishxing.
- Love, M., and Taylor, R. N. (2003). *Fish Passage Evaluation at Stream Crossings*, California Salmonid Stream Habitat Restoration Manual Part IX.
- Peters, R. H. (1983). *The Ecological Implications of Body Size*. Cambridge University Press, Cambridge, UK.
- WDFW (2000). *Fish Passage Barrier and Surface Water Diversion Screening Assessment and Prioritization Manual*, Washington Department of Fish and Wildlife, Olympia, WA.
- USFS (2008). FishXing Web Site: "A Tutorial on Field Procedures for Inventory and Assessment of Road-Stream Crossings for Aquatic Organism Passage." Retrieved March 17, 2007 from <http://www.stream.fs.fed.us/fishxing/PEPs.html>
- USFS (Unpublished). USFS Region 1 Adult and Juvenile Salmonid Fish Screens, U.S. Forest Service Northern Region, Missoula, MT.
- USFWS (2008). USFWS Fish Passage Decision Support System Web Site: "Fish Passage Decision Support System Database." Retrieved July 15, 2008 from <http://fpdss.fws.gov/>

Appendix A UDWR Sensitive Species List

The following contains the introduction to the UDWR SSL and the list of target Utah fish species which possess some level of federal or state protected or threatened status.



State of Utah
Department of Natural Resources
Division of Wildlife Resources

Utah Sensitive Species List

December 14, 2007

This list has been prepared pursuant to Utah Division of Wildlife Resources Administrative Rule R657-48. By rule, wildlife species that are federally listed, candidates for federal listing, or for which a conservation agreement is in place automatically qualify for the *Utah Sensitive Species List*. The additional species on the *Utah Sensitive Species List*, "wildlife species of concern," are those species for which there is credible scientific evidence to substantiate a threat to continued population viability. It is anticipated that wildlife species of concern designations will identify species for which conservation actions are needed, and that timely and appropriate conservation actions implemented on their behalf will preclude the need to list these species under the provisions of the federal Endangered Species Act. Please see Appendix A for the rationale behind each wildlife species of concern designation.

Figure A-1: Introduction to UDWR SSL

Utah Sensitive Species List

Fishes

Federal Candidate Species
(None)

Federally Threatened Species
Lahontan Cutthroat Trout (introduced) *Oncorhynchus clarkii henshawi*

Federally Endangered Species
Humpback Chub *Gila cypha*
Bonytail *Gila elegans*
Virgin Chub *Gila seminuda*
Colorado Pikeminnow *Ptychocheilus lucius*
Woundfin *Plagopterus argentissimus*
June Sucker *Chasmistes liorus*
Razorback Sucker *Xyrauchen texanus*

Conservation Agreement Species
Bonneville Cutthroat Trout *Oncorhynchus clarkii utah*
Colorado River Cutthroat Trout *Oncorhynchus clarkii pleuriticus*
Virgin spinedace *Lepidomeda mollispinis mollispinis*
Least Chub *Iotichthys phlegethontis*
Roundtail Chub *Gila robusta*
Bluehead Sucker *Catostomus discobolus*
Flannelmouth Sucker *Catostomus latipinnis*

Wildlife Species of Concern
Northern Leatherside Chub *Lepidomeda copei*
Southern Leatherside Chub *Lepidomeda aliciae*
Desert Sucker *Catostomus clarkii*
Yellowstone Cutthroat Trout *Oncorhynchus clarkii bouvieri*
Bear Lake Whitefish *Prosopium abyssicola*
Bonneville Cisco *Prosopium gemmifer*
Bonneville Whitefish *Prosopium spilonotus*
Bear Lake Sculpin *Cottus extensus*

Figure A-2: List of Fish on UDWR SSL

Appendix B Examples of Culvert Assessment Procedures

The following contains several prominent culvert assessment procedures and fish screens the fish passage assessment procedure is based on.

Passage Through Crossings Assessment

SITE

Forest _____ District _____ Crossing ID number _____
 Route number: _____ INFRA milepost: _____ Structure _____ of _____
 Milepost: _____ from junction of road no. _____ Structure milepost _____
 Watershed 6th HUC or name: _____ Stream name: _____
 7.5-minute quad name: _____ Land ownership: _____ NF _____ Other: _____
 Legal description: T. ___ S / N, R. ___ E / W, Sec. ___ of ___ 1/4 Principal meridian _____
 X/Y Coordinates _____ Coordinate system _____ Datum _____
 Surveyor names: _____ Field date: ___ / ___ / ___

CROSSING STRUCTURE

Shape

- Circular
- Box
- Open-bottom arch
- Pipe-arch
- Ford
- Vented ford
- Bridge
- Other: _____

Dimensions (inches)

width: _____ height: _____
 Rust line: _____ (feet)
 Ford data: sag _____
 F₁ _____
 F₂ _____

Multiple structures at site:

____ # other openings identical to main structure
 Mileposts _____
 ____ # different openings with forms completed
 ____ # overflow pipes----no forms completed
 Mileposts _____
 ____ # overflow pipes with forms completed

Structure shape comments _____

Structure material

- Spiral CMP
 - Annular CMP
 - Structural plate
 - Concrete
 - PVC
 - Wood or log
 - Other: _____
- Steel Aluminum

Corrugations

- 2 2/3 x 1/4 inch
- 3 x 1 inch
- 5 x 1 inch
- 8 x 2 inch (SSP only)
- None
- Paved or smooth invert
- Other: _____

Skew from road

_____ degrees

Inlet type

- Projecting
 - Mitered
 - Wingwall 10-30°
 - Wingwall 30-70°
 - Headwall
 - Apron
 - Trashrack
 - Other: _____
- Describe: _____

Outlet configuration

- at stream grade
 - cascade over riprap
 - freefall into pool
 - freefall onto riprap
 - outlet apron
 - Other: _____
- Describe: _____

Fill Volume

L_u (upstream fill slope length): _____
 L_d (downstream fill slope length): _____
 S_u (slope of upstream fill): _____ %
 S_d (slope of downstream fill): _____ %
 W_r (Road Width): _____
 W_f (length of road on fill): _____
 W_e (length of fill base): _____

Baffles, weirs or other internal structures: Yes No Material: _____

Describe (see sketch): _____

Pipe condition: Breaks inside culvert (Location _____)

- Fill eroding Debris plugging inlet (% blockage _____) Bent inlet Bottom worn through
- Poor alignment with stream Debris in culvert (rock or wood) Bottom rusted through Water flowing under culvert
- Other _____ Describe overall condition _____

Diversion Potential: Yes No Comments: _____

Figure B-1: Page 1 of U.S. Forest Service National Inventory & Assessment Procedure (Clarkin et al. 2003)

Crossing ID Number _____ Structure ____ of ____

SURVEY

Station ¹	BS (+)	HI	FS (-)	Elevation	Notes
				100.00	

Tailwater Cross Section

Describe:

Station ¹	BS (+)	HI	FS (-)	Elevation	Notes

Long profile (required points)

- P₁ inlet gradient control point
- P₂ inlet invert
- P₃ roadway surface
- P₄ outlet invert
- P₅ pool bottom
- WS₅ or WS₆ water surface at outlet pool taken at P₅ or P₆
- P₆ tailwater control
- P₇ downstream end of profile
- WS₇ water surface at P₇

Tailwater cross-section (minimum recommended points)

- Left bankfull
- Left edge of water
- Left toe of bank
- Thalweg
- Right toe of bank
- Right edge of water
- Right bankfull

¹ Station: The distance (ft) along the profile or transect from the starting point.

Figure B-2: Page 2 of U.S. Forest Service National Inventory & Assessment Procedure (Clarkin et al. 2003)



Crossing ID number _____ Structure ___ of _____

STREAMBED SUBSTRATE RETENTION IN STRUCTURE

No substrate in structure

Discontinuous layer of substrate in structure begins at _____ ft; ends at _____ ft (measured from inlet)

Substrate is continuous throughout structure

If present, substrate depth at inlet _____ ft; substrate depth at outlet _____ ft

SUBSTRATE PARTICLE SIZES number 1up to 3 in order of sizes occupying most streambed area

	Bedrock	Boulders	Cobbles	Gravel	Sand	Silt/Clay	Organics	Aquatic macrophytes
Culvert								
Downstream near tailwater control								

BANKFULL channel widths—outside of culvert influence (ft): (1) _____ (2) _____

(3) _____ (4) _____ (5) _____ **Average** _____

CALCULATIONS FROM SURVEY

Culvert slope: ___ % $\frac{\text{elev}(P_2 - P_4)}{\text{dist}(P_2 - P_4)} \times 100$ Outlet drop (F): ___ (P₄ minus P₆)

Channel gradient: ___ % upst; ___ % downst Inlet gradient: ___ % $\frac{\text{elev}(P_1 - P_2) \times (100)}{\text{dist}(P_1 - P_2)}$

Ratio of inlet width to channel width : _____ Residual inlet depth: _____ (P₆ - P₂)

Substrate ratio: _____ (depth of substrate/structure height) Residual pool depth: _____ (P₆ - P₅)

FIELD PASSAGE EVALUATION

___ Resembles natural channel ___ Passage adequate (species/lifestage) _____

___ Passage indeterminate ___ Passage inadequate (species/lifestage) _____

Comments:

65

Figure B-3: Page 3 of U.S. Forest Service National Inventory & Assessment Procedure (Clarkin et al. 2003)

Crossing ID number _____ Structure ___ of _____

SITE SKETCH

Include:

- North Arrow
- Direction of stream flow
- Culvert/channel alignment
- Lay of tape if needed
- Photo point locations and numbers
- Wingwalls and inlet / outlet aprons
- Multiple structures
- Baffle configurations
- Weirs and other instream structures
- Debris jams inside, upstream and downstream near site, depositional bars
- Trash racks, screens, standpipes etc. that may affect passage
- Damage to or obstacle inside structure
- Location of Riprap for bank armoring or jump pool formation
- Tailwater cross-section location

67

Figure B-5: Page 5 of U.S. Forest Service National Inventory & Assessment Procedure (Clarkin et al. 2003)

Optional Channel Reference Data

Crossing ID Number _____ Structure ___ of ____

CHANNEL SLOPE---- measured outside of culvert influence
Upstream (include upstream channel cross section in reach)

Slope = cumulative elevation change/cumulative distance

Station	BS (+)	HI	FS (-)	Elevation	Cumulative

Upstream slope _____

Downstream

Station	BS (+)	HI	FS (-)	Elevation	Cumulative

Downstream slope _____

Note: Slope measurements should be taken at the water surface and at the same stream feature (such as, pool and pool, or riffle and riffle).

Reference cross-section
Describe location:

Station	BS (+)	HI	FS (-)	Elevation	Notes

Reference cross section recommended points (minimum)			Measured Discharge _____ cfs
Left bankfull	Thalweg	Right toe of bank	Manning's n _____
Left edge of water		Right edge of water	
Left toe of bank		Right bankfull	

Figure B-6: Page 6 of U.S. Forest Service National Inventory & Assessment Procedure (Clarkin et al. 2003)

Crossing ID number _____

Site Biological information - (Core data and prioritization data)

ANALYSIS SPECIES

Species	Core data		Prioritization data	
	Life Stage	Comments	Upstream habitat blocked (mi)	Downstream habitat blocked (mi)
1.				
2.				
3.				
4.				
5.				
6.				
7.				
8.				
9.				
10.				

Habitat Quality Notes:

Watershed Information - Prioritization data

Exotic Species Crossing Barrier

<u>Upstream crossings:</u> No. of crossings _____ Distance to 1 st crossing (ft): _____ Barrier Y <input type="checkbox"/> N <input type="checkbox"/> Distance to 2 nd crossing (ft): _____ Barrier Y <input type="checkbox"/> N <input type="checkbox"/>	<u>Downstream crossings:</u> No. of crossings _____ Distance to 1 st crossing _____ mi Barrier Y <input type="checkbox"/> N <input type="checkbox"/> Distance to 2 nd crossing _____ mi Barrier Y <input type="checkbox"/> N <input type="checkbox"/>
<u>Other upstream barriers:</u> No. of barriers: _____ Distance to 1 st barrier: _____ mi Height _____ ft Distance to 2 nd barrier: _____ mi Height _____ ft	<u>Other downstream barriers:</u> No. of barriers _____ Distance to 1 st barrier: _____ mi Height _____ ft Distance to 2 nd barrier: _____ mi Height _____ ft

Is a barrier necessary at this site to meet management objectives, that is---passage barrier okay?

Yes No

Figure B-7: Page 7 of U.S. Forest Service National Inventory & Assessment Procedure (Clarkin et al. 2003)

Road - Stream Crossing Survey

Draft E

Date _____ (mm/dd/yy) Time _____ Sequence # _____		Site ID _____	
Observer (s) _____		Organization _____	
Stream _____		Tributary to _____	
Town _____			
Road _____		Type <input type="checkbox"/> Paved <input type="checkbox"/> Unpaved <input type="checkbox"/> Railroad <input type="checkbox"/> Trail <input type="checkbox"/> Driveway	
GPS Coordinates [WGS84 UTM Zone 19N Meters] <input type="text" value="0"/>		East <input type="text"/> North <input type="text"/>	
DeLorme Atlas Map Page _____		Grid Reference _____	
Photo IDs Inlet _____		Outlet _____	
US from Inlet _____		DS from Outlet _____	
RR Approach _____		RL Approach _____	
		High Flow <input type="checkbox"/> Yes <input type="checkbox"/> No	
Basic Structure Type <input type="checkbox"/> Bridge <input type="checkbox"/> Culvert <input type="checkbox"/> Multiple Culverts # _____		<input type="checkbox"/> Ford <input type="checkbox"/> Removed Structure	
Material <input type="checkbox"/> Metal <input type="checkbox"/> Concrete <input type="checkbox"/> Plastic <input type="checkbox"/> Wood <input type="checkbox"/> Stone <input type="checkbox"/> Other _____			
▶ ▶ ▶ ▶ ▶ ▶ TURN OVER to record Specific Structure Type and Dimensions ▶ ▶ ▶ ▶ ▶ ▶			
Internal Structures <input type="checkbox"/> None <input type="checkbox"/> Baffles <input type="checkbox"/> Weirs (Describe in Comments) _____		Corrugations <input type="checkbox"/> Yes <input type="checkbox"/> No	
Slope Compared to Channel Slope <input type="checkbox"/> Higher <input type="checkbox"/> Lower <input type="checkbox"/> Same		Alignment <input type="checkbox"/> Flow-Aligned <input type="checkbox"/> Skewed	
Inlet Condition <input type="checkbox"/> At Stream Grade <input type="checkbox"/> Inlet Drop		Outlet Condition <input type="checkbox"/> At Stream Grade	
<input type="checkbox"/> Perched <input type="checkbox"/> Blocked <input type="checkbox"/> Deformed		<input type="checkbox"/> Perched <input type="checkbox"/> Cascade	
Inlet Water Depth: _____ ft/m		Outlet Water Depth: _____ ft/m	
Outlet Drop _____ ft/m		Tailwater Pool <input type="checkbox"/> No <input type="checkbox"/> Yes Depth <input type="checkbox"/> < 3 ft / 1 m <input type="checkbox"/> > 3 ft / 1 m	
Substrate in Structure <input type="checkbox"/> None <input type="checkbox"/> Bedrock <input type="checkbox"/> Boulder <input type="checkbox"/> Cobble <input type="checkbox"/> Gravel <input type="checkbox"/> Sand <input type="checkbox"/> Clay <input type="checkbox"/> Organic <input type="checkbox"/> Unknown			
<input type="checkbox"/> Continuous <input type="checkbox"/> Discontinuous			
Upstream Substrate <input type="checkbox"/> Bedrock <input type="checkbox"/> Boulder <input type="checkbox"/> Cobble <input type="checkbox"/> Gravel <input type="checkbox"/> Sand <input type="checkbox"/> Clay <input type="checkbox"/> Organic <input type="checkbox"/> Unknown			
Downstream Substrate <input type="checkbox"/> Bedrock <input type="checkbox"/> Boulder <input type="checkbox"/> Cobble <input type="checkbox"/> Gravel <input type="checkbox"/> Sand <input type="checkbox"/> Clay <input type="checkbox"/> Organic <input type="checkbox"/> Unknown			
Channel Width _____ ft/m <input type="checkbox"/> Bankfull Width <input type="checkbox"/> Wetted Width <input type="checkbox"/> Measured <input type="checkbox"/> Estimated			
Significant Sediment Source <input type="checkbox"/> Road / Ditches <input type="checkbox"/> Embankment <input type="checkbox"/> Stream Banks <input type="checkbox"/> Upstream <input type="checkbox"/> Downstream			
Wildlife Barriers <input type="checkbox"/> High Traffic Volume <input type="checkbox"/> Steep Embankments <input type="checkbox"/> Retaining Walls <input type="checkbox"/> Jersey Barriers <input type="checkbox"/> Fencing			
Comments: _____			

Figure B-8: Page 1 of the USFWS Maine Road Crossing Survey Manual Draft-E (Abbot 2007)

Structure Type & Dimensions

Specific Structure Type (see below): 1 2 3 4 5 6 7 Ford

All Dimensions Measured Estimated Units Feet Meters Sliplined Culvert

Inlet Dimensions: A) _____ B) _____ C) _____ D) _____

Outlet Dimensions: A) _____ B) _____ C) _____ D) _____

Length of stream through crossing (ft/m): E) _____

1

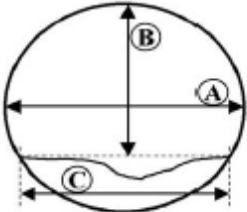

Round Culvert

2

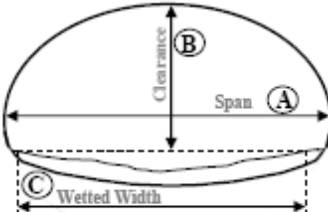

Pipe Arch Culvert

3

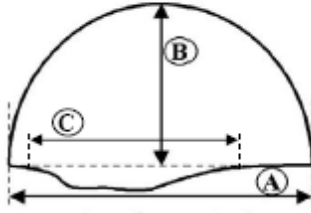

Open Bottom Arch

4

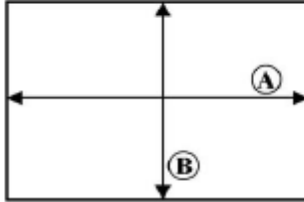

Box Culvert

5

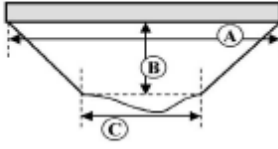

Bridge with Side Slopes

6

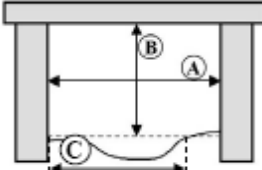

Bridge with Abutments
OR
Bottomless Box Culvert

7

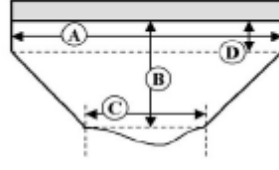

Bridge with Abutments
and Side Slopes

Maine Road-Stream Crossing Survey Field Form - Draft E 3/23/2007

Figure B-9: Page 2 of the USFWS Maine Road Crossing Survey Manual Draft-E (Abbot 2007)

SITE IDENTIFICATION FIELD FORM (6/2200)

¹Site ID: _____ GPS Position Taken: Yes No
²Identifying Group: _____ ³Road Name: _____
⁴Milepost: _____ ⁵County: _____
⁶¼ Sec: _____ Section: _____ Township: _____ Range: _____
⁷Location/Directions: _____

⁸Stream Name: _____ ⁹WRIA #: _____
¹⁰Tributary To: _____ ¹¹River Mile: _____

¹²Fish Use: Yes No Unknown

¹³Fish Use Criteria: Mapped Physical Biological Other

¹⁴Species: Chinook Chum Sockeye Coho Pink
Steelhead Resident Cutthroat/Rainbow Trout
Searun Cutthroat Bull/Dolly Varden Trout
Brook Trout Brown Trout

¹⁵Feature Type: Culvert Fishway Dam Gravity Diversion
Pump Diversion Other

¹⁶Site Comments: _____

¹⁷Evaluation Level: RL FR DC PS TD ETD

¹⁸OWNER INFORMATION

Type: Federal State County City Tribal Private Other
Name: _____
Street Address: _____
Mailing Address: _____
City: _____ State: _____ Zip: _____
Phone #: _____
Contact Name & Phone#: _____

Figure B-10: Page 1 WDFW (2000) Fish Passage Barrier Assessment

SITE FORM INSTRUCTIONS

- 1.) Site ID number (unique site identifier).
- 2.) Group or agency making report.
- 3.) Road name - name of road (if any) on which the barrier resides.
- 4.) Road milepost to the nearest 1/10. **WDFW crews only.**
- 5.) County name.
- 6.) Legal description.
- 7.) Directions to the site.
- 8.) Name of stream associated with the site.
- 9.) Watershed Resource Inventory Area number.
- 10.) Name of stream at first major confluence.
- 11.) River mile to the nearest 1/10 from first major confluence.
- 12.) Indicate whether or not the stream is fish bearing.
- 13.) How was fish bearing determination made?
- 14.) Fish species known to be present in the stream or fish species that would be expected to benefit from the correction of the barrier.
- 15.) Type of feature encountered.
- 16.) Any comments relating to the operation or characteristics of the structure identified above.
- 17.) Completed level of evaluation (multiple entries allowed). Codes:
RL - report logged, FR - field review, DC - downstream check,
PS - physical survey, TD - threshold determination, ETD -
expanded threshold determination.
- 18.) Owner information (if known).

Figure B-11: Page 2 WDFW (2000) Fish Passage Barrier Assessment

CULVERT EVALUATION FIELD FORM (Level A Anal.) (5/22/00)

¹Site ID: _____

²Sequencer: _____

³Field Review Team

Crew: _____

Date: _____

CULVERT DESCRIPTION

⁴Shape: RND BOX ARCH
SOSH ELL OTH

⁵Material: PCC CPC CST
SST CAL SPS SPA PVC
TMB MRY OTH

⁶Span/Dia: _____ ⁷Rise _____ ⁸H₂O Depth in Culv: _____

⁹Outfall Drop: _____ ¹⁰Length _____ ¹¹Slope: _____

¹²Streambed Material Throughout Culvert: Yes No Unknown

¹³Velocity: _____ ¹⁴Apron: None US DS Both

¹⁵Tidegate: Yes No ¹⁶Fill Depth: _____

PLUNGE POOL DESCRIPTION

¹⁷Length: _____ ¹⁸Maximum Depth: _____

¹⁹OHW Width: _____

CHANNEL DESCRIPTION

²⁰Average Streambed Toe Width: _____

²¹Culvert Span/Streambed Toe Width Ratio: _____

SUMMARY INFORMATION

²²Maintenance Required: No Yes/FP Yes/OM

²³Recheck: No GPS Photo Pass HF Pass LF LB

²⁴Barrier: Yes No Unknown

²⁵% Passability: 0 33 67 100

²⁶Problem w/Culvert: Outfall Drop Slope Velocity Depth

²⁷Repair Status: OK NG RR FX FXFW UD

²⁸Comments: _____

Figure B-12: Page 3 WDFW (2000) Fish Passage Barrier Assessment

LEVEL A FORM INSTRUCTIONS

- 1.) Site ID number (Unique site identifier)
- 2.) Sequencer - If 1 culvert at site then 1.1, if 2 then 1.2 or 2.2
- 3.) Field review team information
- 4.) Cross-sectional shape of the culvert. RND - round, BOX - square or rectangular, ARCH - bottomless, SQSH - squash (pipe arch), ELL - elliptical, OTH - other
- 5.) Material Pipe is composed of. PCC - pre-cast concrete, CPC - cast-in-place concrete, CST - corrugated steel, SST - smooth steel, CAL - corrugated aluminum, SPS - structural plate steel, SPA - structural plate aluminum, PVC - polyvinylchloride, TMB - timber, MRY - masonry, OTH - other
- 6.) Maximum width of the culvert to the nearest 0.01 meter.
- 7.) Height of the culvert to the nearest 0.01 meter.
- 8.) Water depth in culvert to the nearest 0.01 meter.
- 9.) Difference between the water surface in the culvert at the DS end and the water surface immediately DS of the culvert.
- 10.) Length of the culvert to the nearest 0.1 meter.
- 11.) % slope of the culvert $(US\ IE-DS\ IE\ Length)^*100$
- 12.) Is there streambed material throughout the culvert?
- 13.) Water velocity inside the culvert in meters per second.
- 14.) Is there an apron attached to either or both ends of the culvert?
- 15.) Is there a tidegate associated with the culvert?
- 16.) Estimated height of the road fill. **WDFW crews only.**
- 17.) Length of the plunge pool to the 0.01 meters.
- 18.) Maximum depth of the plunge pool to the nearest 0.01 meters.
- 19.) Ordinary high water width of the plunge pool to the nearest 0.01 meters.
- 20.) The average streambed toe width outside of the influence of the culvert to the nearest 0.01 meters.
- 21.) The ratio of the width of the culvert to the toe width of the stream.
- 22.) Does the culvert require maintenance? If yes, does the need for maintenance affect fish passage? If so, check the yes/tp block. **WDFW crews only.**
- 23.) Is there a need to recheck the culvert in the future? No - no need, GPS - GPS position needed, Photo - photo needed, Pass HF - evaluate passage at high flow, Pass LF - evaluate passage at low flow, LB - Level B data required. **WDFW crews only.**
- 24.) Barrier status of the culvert.
- 25.) Estimated percent passability of the culvert. **WDFW crews only.**
- 26.) If the culvert is a barrier, what is the problem? Check all that apply.
- 27.) The current repair status of the culvert. OK - non-barrier, NG - no gain, RR - repair required, FX - fixed, FX/PW - repaired and converted to a fishway, UD - undetermined, habitat assessment incomplete.
- 28.) Comments regarding the culvert.

Figure B-13: Page 4 WDFW (2000) Fish Passage Barrier Assessment

CULVERT EVALUATION FIELD FORM (Level B Analysis) (62200)

¹Site ID: _____

²Sequencer: _____

⁴Datum: _____

⁶Datum Location: _____

³ Field Review Team
Crew: _____
Date: _____

UPSTREAM MEASUREMENTS

⁶Invert Elevation: _____ ⁷Culvert Bed Elevation: _____

⁸Corrugation: Smooth 0.5"x2.66" 1"x3" 2"x6" Paved Invert
Other _____

DOWNSTREAM MEASUREMENTS

⁹Invert Elevation: _____ ¹⁰Culvert Bed Elevation: _____

¹¹DOWNSTREAM CONTROL CROSS-SECTION

	Top LB	Toe LB	Bed 1	Bed 2	Bed 3	Toe RB	Top RB
Station	0						
Bed Elevation							

¹²Water Surface Elevation at DS Control: _____

¹³OHW Elevation at DS Control: _____

¹⁴Water Surface Elevation 15m DS of DS Control: _____

¹⁵Dominant Channel Substrate Composition: Bedrock Boulder
Riprap Cobble Gravel Sand Mud

Figure B-14: Page 5 WDFW (2000) Fish Passage Barrier Assessment

LEVEL B FORM INSTRUCTIONS

- 1.) Site ID number (Unique site identifier)
- 2.) Sequencer - If 1 culvert at site then 1.1, if 2 then 1.2 (meaning culvert 1 of 2) or 2.2 (meaning culvert 2 of 2).
- 3.) Field review team information.
- 4.) What is the datum (benchmark) elevation?
- 5.) Location of the datum.
- 6.) Elevation of the invert (bottom) of the culvert at the upstream end to the nearest 0.01 meter.
- 7.) The elevation of the streambed, if any, at the upstream end of the culvert.
- 8.) Corrugation dimensions in inches, measured valley to peak and peak to peak. If the corrugations at the culvert invert are completely covered with asphalt or concrete, enter paved.
- 9.) Elevation of the invert (bottom) of the culvert at the downstream end to the nearest 0.01 meter.
- 10.) The elevation of the streambed, if any, at the downstream end of the culvert.
- 11.) The downstream control is the normally head of the first riffle downstream of the culvert. Start at the top of left bank (station 0, facing downstream) and proceed to the right taking up to 7 elevations, to the nearest 0.01 meters, to describe the cross-sectional profile of the stream. The station is the distance, to the nearest 0.01 meters, from station 0 to the location the bed elevation was taken.
- 12.) Water surface elevation at the downstream control.
- 13.) Ordinary high water elevation at the downstream control.
- 14.) Water surface elevation 15 meters downstream of the downstream control to the nearest 0.01 meter.
- 15.) Dominant channel substrate between the downstream end of the culvert and the point 15 meters downstream of the downstream control.

Figure B-15: Page 6 WDFW (2000) Fish Passage Barrier Assessment

Level B Analysis Elevations Worksheet (6/2/00)

Site ID: _____

Datum Elevation (Benchmark): _____

Datum Location: _____

	BS	HI	RH	FS	ELEV	DEPTH	WSE
Benchmark							
US Invert Elev							
US Culvert Bed Elev							
DS Invert Elev							
DS Culvert Bed Elev							
DS Water Surf. Elev							
Downstream Control Cross-Section							
	STA						
Top LB	ST0	0					
Toe LB	ST1						
Bed 1	ST2						
Bed 2	ST3						
Bed 3	ST4						
Toe RB	ST5						
Top RB	ST6						
OHW Elev.							

Average Water Surface Elevation at Downstream Control (WSE): _____

Elevation calculations:

1) Laser Reading (+): Subtract the laser reading from the rod height (RH) then subtract the remainder from the instrument height (HI).

2) Laser Reading (-): Subtract both the laser reading and the rod height (RH) from the instrument height (HI).

Figure B-16: Page 7 WDFW (2000) Fish Passage Barrier Assessment

FISH PASSAGE INVENTORY DATA SHEET

Stream Crossing Type: bridge ford culvert other _____ Date: ___/___/___
 Surveyors: Scope: _____ Rod: _____
 Culvert # _____ of _____ (left bank to right bank)

Road:	Mile Post:	Crossroad:
Stream Name:	Tributary to:	Basin:
Quad:	T: R: S:	Lat/Long:
Flow Conditions During Survey: <input type="checkbox"/> continuous <input type="checkbox"/> isolated pools <input type="checkbox"/> dry		
Fisheries Information		
Fish Presence Observed During Survey: Location: <input type="checkbox"/> upstream <input type="checkbox"/> downstream <input type="checkbox"/> none Age Classes: <input type="checkbox"/> adults <input type="checkbox"/> juveniles Species: _____ <input type="checkbox"/> unknown Juvenile Size Classes: <input type="checkbox"/> <3" <input type="checkbox"/> 3"-6" <input type="checkbox"/> >6" Number of Fish Observed: _____		
Stream Crossing Information		
Inlet Type: <input type="checkbox"/> projecting <input type="checkbox"/> headwall <input type="checkbox"/> wingwall <input type="checkbox"/> mitered <input type="checkbox"/> flared Alignment (deg): <input type="checkbox"/> <30° <input type="checkbox"/> 30°-45° <input type="checkbox"/> >45° Inlet Apron: <input type="checkbox"/> yes <input type="checkbox"/> no Describe: _____ Outlet Configuration: <input type="checkbox"/> at stream grade <input type="checkbox"/> free-fall into pool <input type="checkbox"/> cascade over rip rap Outlet Apron: <input type="checkbox"/> yes <input type="checkbox"/> no Describe: _____ Tailwater Control: <input type="checkbox"/> pool tailout <input type="checkbox"/> full-spanning log or debris jam <input type="checkbox"/> log weir <input type="checkbox"/> boulder weir <input type="checkbox"/> concrete weir <input type="checkbox"/> other _____ <input type="checkbox"/> no control point (complete a channel cross-section) Upstream Channel Widths (ft): (1) (2) (3) (4) (5) Average Width: _____		
Culvert Information		
Culvert Type: <input type="checkbox"/> circular <input type="checkbox"/> pipe arch <input type="checkbox"/> box <input type="checkbox"/> open-bottom arch <input type="checkbox"/> other _____ Diameter (ft): _____ Height or Rise (ft): _____ Width or Span (ft): _____ Length (ft): _____ Material: <input type="checkbox"/> SSP <input type="checkbox"/> CSP <input type="checkbox"/> aluminum <input type="checkbox"/> plastic <input type="checkbox"/> concrete <input type="checkbox"/> log/wood <input type="checkbox"/> other _____ Corrugations (width x depth): <input type="checkbox"/> 2 2/3" x 1/2" <input type="checkbox"/> 3" x 1" <input type="checkbox"/> 5" x 1" <input type="checkbox"/> 6" x 2" <input type="checkbox"/> spiral <input type="checkbox"/> other _____ Pipe Condition: <input type="checkbox"/> good <input type="checkbox"/> fair <input type="checkbox"/> poor <input type="checkbox"/> extremely poor Describe: _____ Rustline Height (ft): _____ <input type="checkbox"/> NP (new CSP or SSP) <input type="checkbox"/> NA (concrete, aluminum, plastic) Embedded: <input type="checkbox"/> yes <input type="checkbox"/> no Depth (ft): inlet _____ outlet _____ Station (ft): start: _____ end: _____ Describe Substrate: _____ Barrel Retrofit (weirs/baffles): <input type="checkbox"/> yes <input type="checkbox"/> no Type: <input type="checkbox"/> steel ramp baffles <input type="checkbox"/> Washington <input type="checkbox"/> corner <input type="checkbox"/> other: _____ Describe (size, number, placement, materials): _____ Outlet Beam: <input type="checkbox"/> yes <input type="checkbox"/> no Notched: <input type="checkbox"/> yes <input type="checkbox"/> no Breaks-in-Slope: <input type="checkbox"/> yes <input type="checkbox"/> no Number: _____ Fill Volume: L ₁ (ft): _____ S ₁ (%): _____ W _r (ft): _____ L _d (ft): _____ S _d (%): _____ L _f (ft): _____ W _a (use average channel width) (ft): _____		

Figure B-17: Page 1 of the Love (2003) Fish Passage Evaluation at Stream Crossings

FISH PASSAGE INVENTORY SURVEYED ELEVATIONS

Longitudinal Surveyed Elevations					Station Description and Water Depth (Bold = Required)	Tailwater Cross-section (optional)					
Station (ft)	BS (+)	HI (ft)	FS (-)	Elevation (ft)		Station (ft)	BS (+)	HI (ft)	FS (-)	Elevation (ft)	Notes
					TBM:						
					TW Control of 1 st resting habitat w/s of inlet						
					Inlet Apron/Riprap						
					Inlet Depth=						
					Outlet Depth=						
					Outlet Apron/Riprap						
					Max. Depth within =						
					Max. Pool Depth						
					TW Control Depth=						
					Active Channel Stage						
					Downstream Channel Slope (%):	Substrate at X-Section:					
					Additional Surveyed Elevations (including Breaks-in-Slope)	Suspected Passage Assessment:					
						Adults: <input type="checkbox"/> 100% barrier <input type="checkbox"/> partial barrier <input type="checkbox"/> no barrier					
						Juveniles: <input type="checkbox"/> 100% barrier <input type="checkbox"/> partial barrier <input type="checkbox"/> no barrier					
						Culvert Slope: _____ %					

Qualitative Habitat Comments:

Figure B-18: Page 2 of the Love (2003) Fish Passage Evaluation at Stream Crossings

Site Sketch

Figure B-19: Page 3 of the Love (2003) Fish Passage Evaluation at Stream Crossings

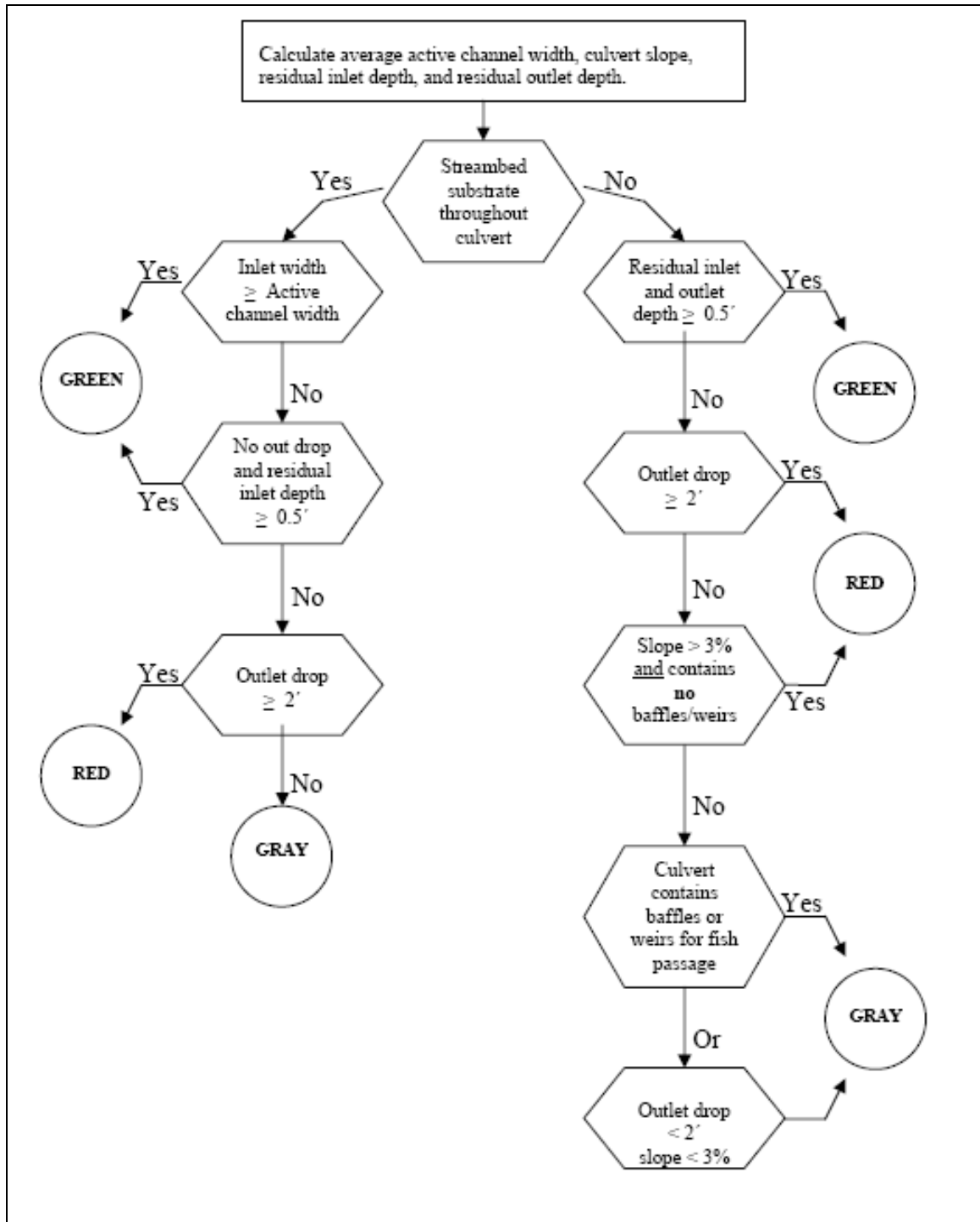

Figure B-20: Salmonid Fish Screen Love (2003) Fish Passage Evaluation at Stream Crossings

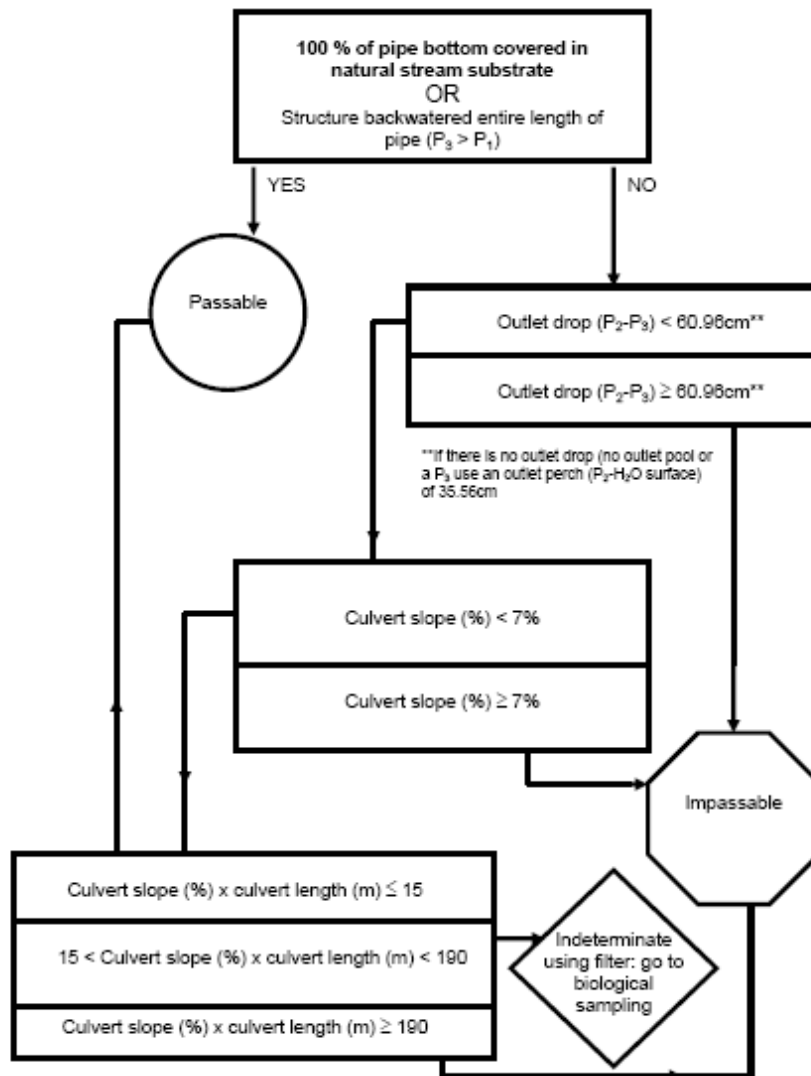

Figure 3. Modified upstream fish passage predictive model A for Salmonidae. See Figure 1.1 for a profile of survey points used in fish passage coarse filter. P_n = elevation measurements.

Figure B-21: Coffman (2005) Group (A) Adult Salmonid Fish Screen

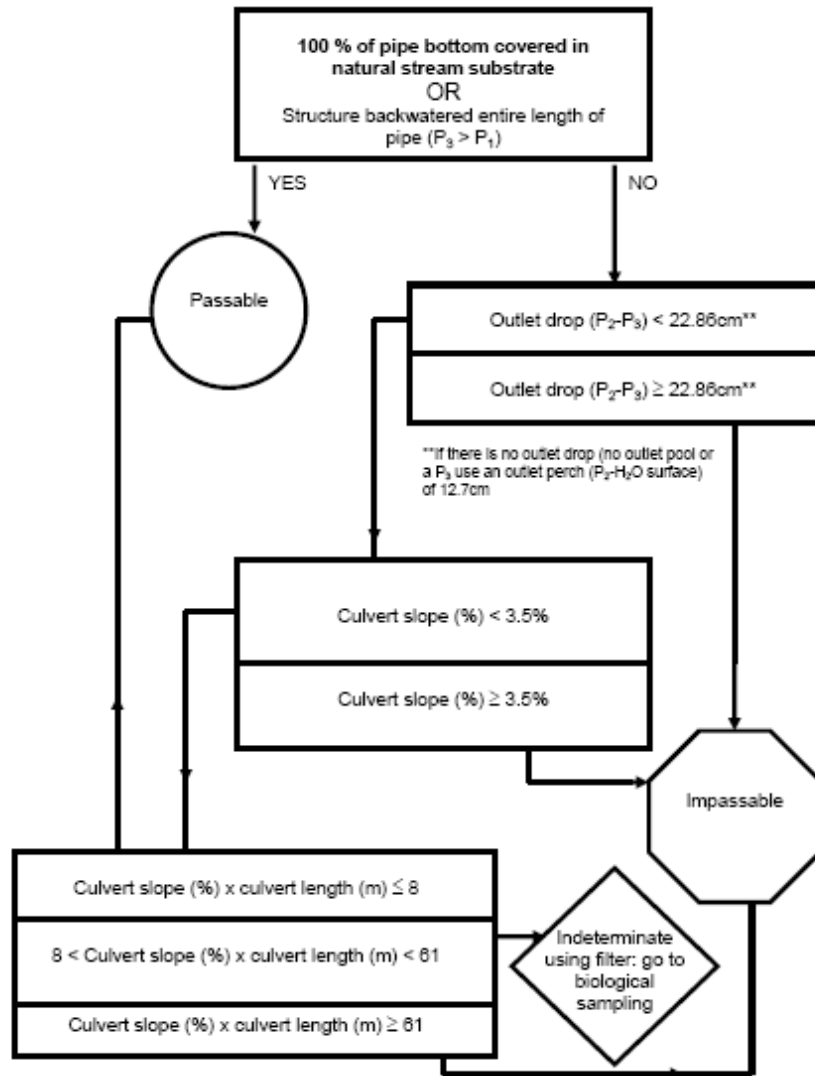

Figure 7. Modified upstream fish passage predictive model B for Cyprinidae and young of year salmonids. See Figure 1.1 for profile of survey points used in fish passage coarse filter. P_n = elevation measurements.

Figure B-22: Coffman (2005) Group (B) Young of Year Salmonid & Cyprinidae Fish Screen

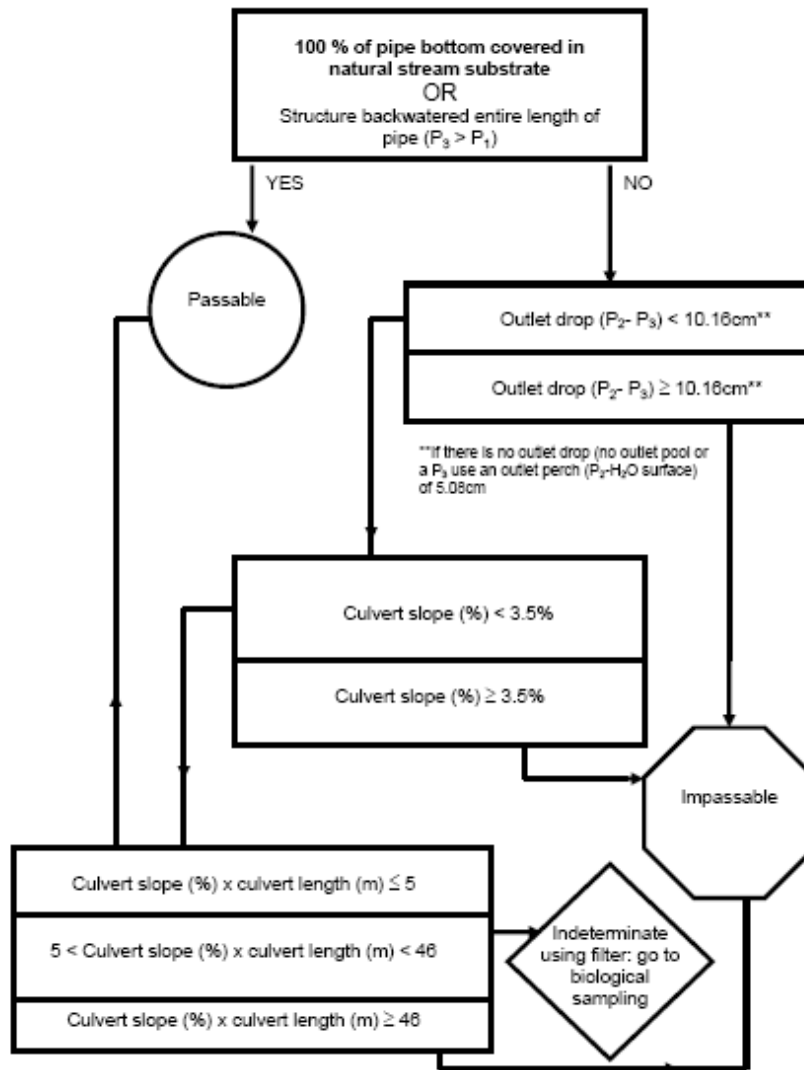

Figure 11. Modified upstream fish passage predictive model C for Percidae (except *Sander vitreus*, *Stizostedion canadense*, and *Perca flavescens*), and Cottidae families. See Figure 1.1 for profile of survey points used in fish passage coarse filter. P_n = elevation measurements.

Figure B-23: Coffman (2005) Group (C) Cottidae & Percidae Fish Screen

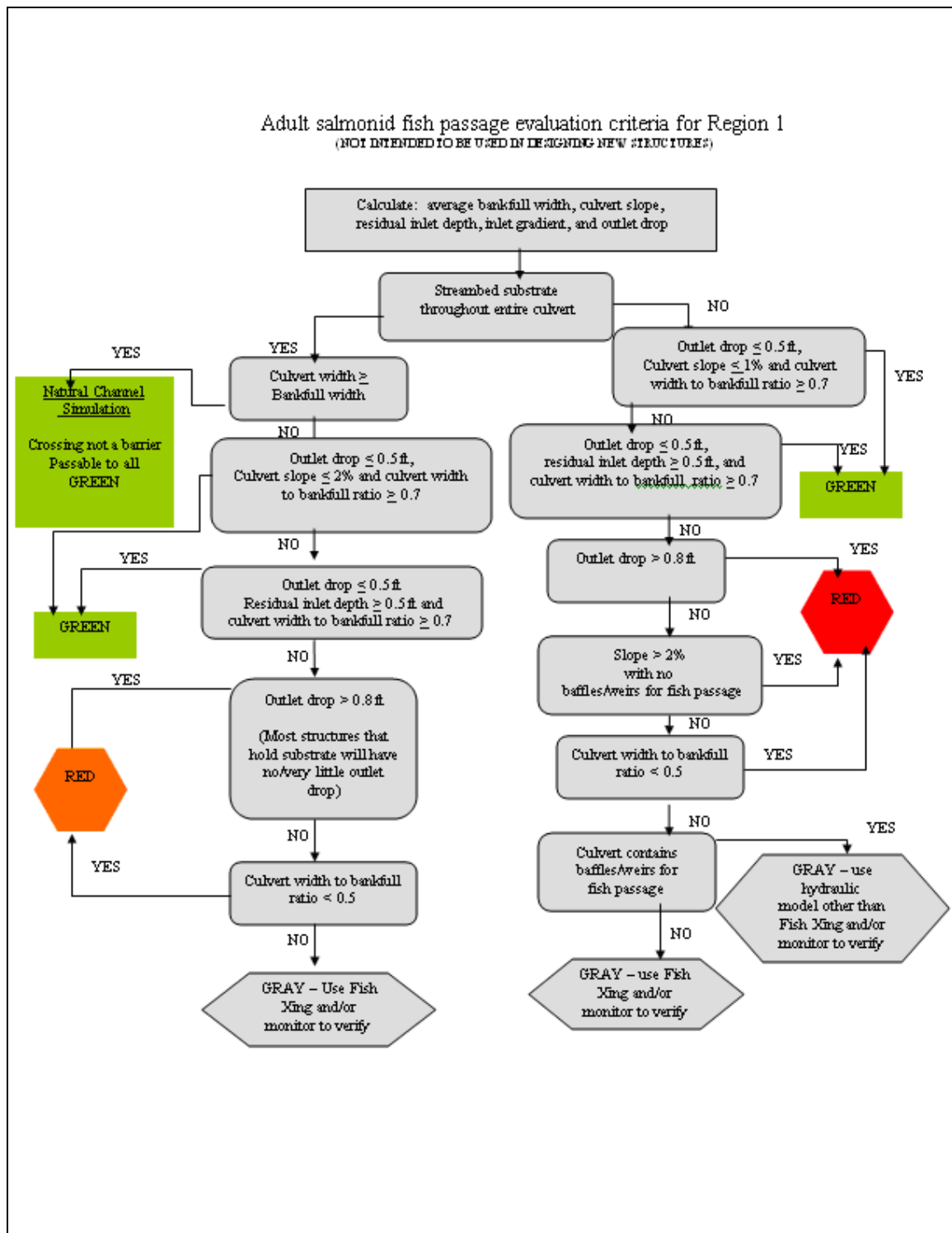

Figure B-24: USFS (Unpublished) Region 1 Adult Salmonid Fish Screen

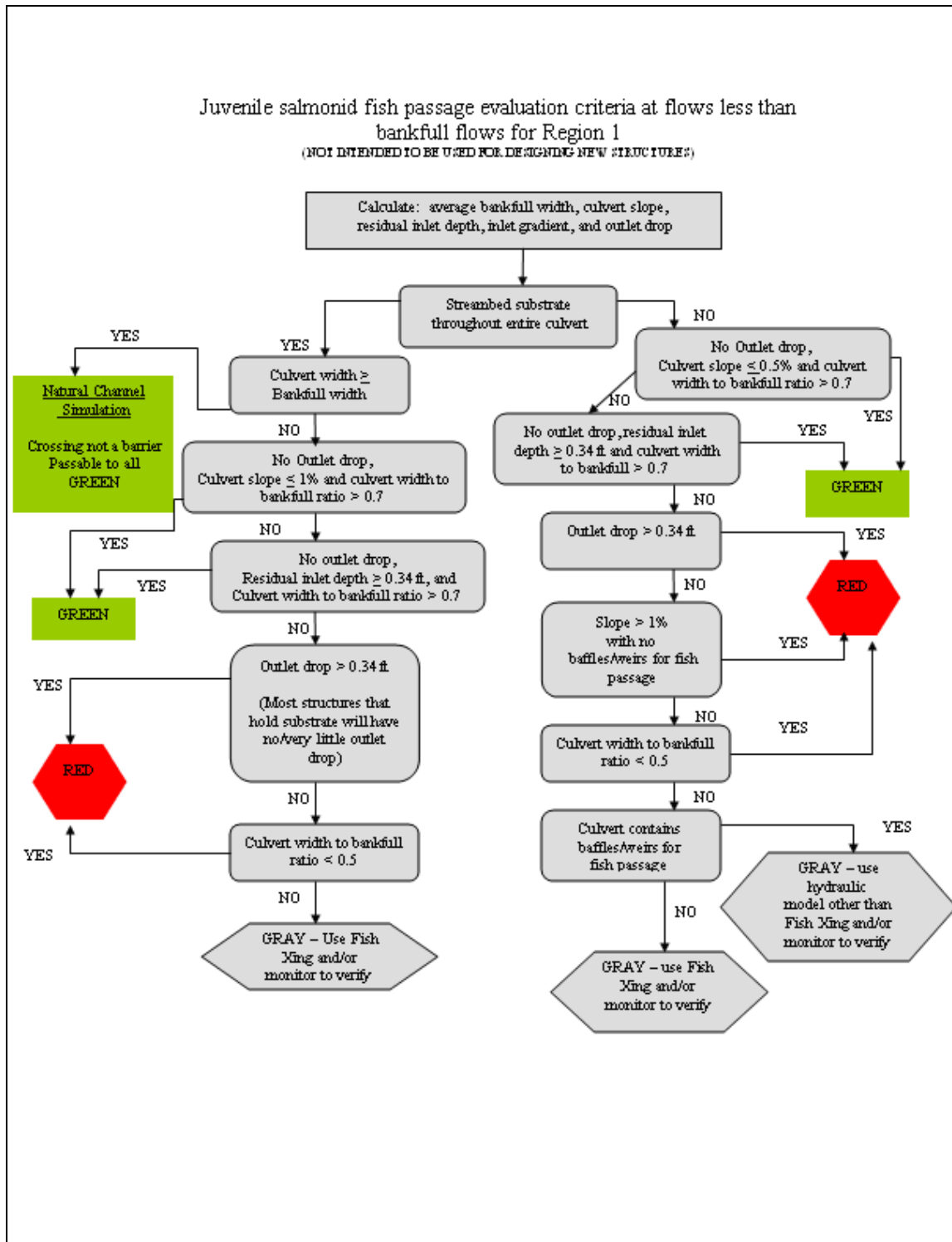

Figure B-25: USFS (Unpublished) Region 1 Juvenile Salmonid Fish Screen

Appendix C Field Verification Data

Mark and Recapture Data

Table C-1: Capture Data for Upstream Fish Population at Soldier Creek Mark and Recapture Site

Soldier Upstream							
Latitude:	39.99365	*Both yellow tagged fish were shocked near the culvert inlet (10m upstream of the culvert inlet)					
Longitude:	111.493941						
Date:	12-Apr-07	All fish were released 20m upstream of the culvert inlet					
Color:	Green						
Total Tagged Fish:	135	[fish]	Fish standard length was measured and recorded in mm				
Individual Specie Totals							
	2	41	12	80	0	0	0
	Leatherside	Mnt. Sucker	Sculpin	Long nose	Speckled	Brown	Cutthroat
	87	90	46	65			
	80	135	55	73			
		115	73	70			
		145	55	65			
		82	43	65			
		132	50	75			
		120	53	63			
		155	49	62			
		160	47	67			
		160	50	65			
		125	53	55			
		122	49	70			
		115		70			
		135		64			
		125		65			
		127		82			
		150		50			
		110		70			
		143		66			
		115		73			
		133		71			
		65		64			
		110		87			
		148		61			
		115		62			
		145		56			
		115		72			
		105		73			
		145		110			
		126		74			
		140		72			
		122		71			
		128		67			
		120		68			
		125		62			
		45		57			
		123		62			
		114		70			
		125		65			
		112		75			
		143		75			
				80			
				80			
				73			
				70			
				71			
				72			
				80			
				65			
				65			
				70			
				65			
				63			
				73			
				72			
				82			
				58			
				75			
				70			
				70			
				66			
				66			
				68			

Table C-2: Capture Data for Downstream Fish Population at Soldier Creek Mark and Recapture Site

Soldier Downstream							
Latitude:	39.99365	All fish were released 10 meters downstream of the culvert outlet					
Longitude:	111.493941	Fish standard length was measured and recorded in mm					
Date:	24-Mar-07						
Color:	Yellow						
Total Tagged Fish:	329	[fish]					

Individual Specie Totals							
0	119	136	42	29	0	3	0
Leatherside	Mnt. Sucker	Sculpin	Long nose	Speckled	Brown	Cutthroat	Rainbow
74	94	79	68		103		
68	102	88	64		103		
68	91	75	62		74		
85	152	79	68				
69	124	74	67				
87	103	48	54				
80	112	40	72				
71	127	79	70				
74	116	49	69				
76	142	74	38				
57	125	82	50				
68	126	78	56				
64	94	78	69				
59	115	84	61				
71	82	73	69				
84	79	82	52				
71	116	80	68				
83	89	84	55				
71	116	78	64				
58	142	73	70				
58	108	44	64				
59	114	46	64				
60	132	80	82				
49	83	79	63				
66	74	69	50				
53	106	43	64				
53	74	94	74				
55	107	78	60				
52	92	82	53				
74	121	95					
87	126	81					
61	112	68					
67	68	86					
69	76	54					
62	75	67					
60	57	78					
100	63	52					
56	130	88					
63	109	75					
49	120	105					
57	135	49					
58	125	48					
51	94						
78	86						
66	109						
71	94						
91	114						
71	125						
64	94						
65	87						
69	67						
64	69						
69	67						
66	71						
61	57						
68	130						
62	121						
69	138						
85	97						
68	124						
92	130						
68	122						
70	110						

Table C-3: Capture Data for Downstream Fish Population at Diamond Fork #1 Mark and Recapture Site

Diamond Culvert #1 Downstream							
Latitude:	40.027183	Culvert #1: This Culvert was located at the Rail Road Tracks Upstream of the Old Hwy Bridge					
Longitude:	111.50349	This tagging represents the area downstream of this culvert					
Date:	7-Apr-07	All fish were released 10 meters downstream of the culvert outlet					
Color:	Orange	Fish standard length was measured and recorded in mm					
Total Tagged Fish:	49 [fish]						
Individual Specie Totals							
0	5	33	0	0	10	1	0
Leatherside	Mnt. Sucker	Sculpin	Long nose	Speckled	Brown	Cutthroat	Rainbow
	102	72			197	68	
	72	65			420		
	132	46			234		
	75	66			227		
	70	69			350		
		85			343		
		72			379		
		74			87		
		72			106		
		70			109		
		74					
		77					
		74					
		74					
		73					
		69					
		65					
		72					
		73					
		67					
		69					
		74					
		71					
		70					
		67					
		60					
		65					
		65					
		65					
		61					
		60					
		73					
		62					

Table C-4: Capture Data for Upstream Fish Population at Diamond Fork #1 and Downstream Population at Diamond Fork #2 Mark and Recapture Sites. This is the Transect Between These Two Culverts

Diamond Culvert #2 Upstream							
Latitude:	40.028167	Culvert #2: This Culvert was located at HWY 6 aprox. 25 meters upstream of Culvert #1					
Longitude:	111.501325	This tagging represents the area upstream of Culvert #2					
Date:	7-Apr-07	All fish were released 20m upstream of the Culvert #2 inlet					
Color:	Green	Fish standard length was measured and recoreded in mm					
Total Tagged Fish:	35	[fish]					
Individual Specie Totals							
0	1	18	0	0	16	0	0
Leatherside	Mnt. Sucker	Sculpin	Long nose	Speckled	Brown	Cutthroat	Rainbow
	150	50			280		
		85			300		
		70			295		
		80			300		
		50			320		
		70			295		
		60			350		
		75			320		
		85			291		
		75			320		
		82			235		
		90			230		
		85			215		
		60			225		
		62			350		
		70			315		
		63					
		50					

Table C-5: Capture Data for Upstream Fish Population at Diamond Fork #2 Mark and Recapture Site

Diamond Culvert #1 Upstream							
Latitude:	40.027183	Culvert #1: This Culvert was located at the Rail Road Tracks Upstream of the Old Hwy Bridge					
Longitude:	111.50349	This tagging represents the area upstream of Culvert #1 between Culvert #1 and Culvert #2					
Date:	7-Apr-07	All fish were released 10 meters downstream of the Culvert #2 outlet					
Color:	Pink	Fish standard length was measured and recoreded in mm					
Total Tagged Fish:	13	[fish]					
Individual Specie Totals							
0	11	1	1	0	0	0	0
Leatherside	Mnt. Sucker	Sculpin	Long nose	Speckled	Brown	Cutthroat	Rainbow
	74	80	70				
	105						
	110						
	89						
	98						
	93						
	94						
	87						
	100						
	83						
	72						

Table C-6: Capture Data for Upstream Fish Population at Salina Creek Mark and Recapture Site

Salina Upstream								
Latitude:	38.882097	All fish were released 20m upstream of the culvert inlet						
Longitude:	111.577524	Fish standard length was measured and recoreded in mm						
Date:	14-Apr-07							
Color:	Pink							
Total Tagged Fish:	204	[fish]						
Individual Specie Totals								
79	83	10	0	25	5	1	1	
Leatherside	Mnt. Sucker	Sculpin	Long nose	Speckled	Brown	Cutthroat	Rainbow	
80	151	65		86	270	254	240	
78	132	79		79	275			
86	150	74		75	275			
84	165	74		78	184			
83	137	71		78	125			
83	97	75		75				
92	110	77		70				
83	137	91		60				
80	125	60		90				
78	120	68		68				
58	166			70				
112	187			57				
62	158			77				
87	175			69				
66	100			78				
87	125			69				
66	140			64				
86	189			83				
67	145			86				
58	102			67				
58	162			66				
80	168			74				
101	170			80				
83	135			67				
60	170			73				
72	130							
76	185							
82	130							
87	173							
85	132							
94	195							
110	175							
125	181							
115	138							
85	187							
80	105							
84	164							
10	109							
85	99]							
78	177							
98	148							
83	180							
100	180							
88	201							
78	90							
85	150							
80	104							
70	101							
87	168							
86	160							
62	110							
63	160							
87	116							
122	158							
79	104							
84	160							
110	106							
108	70							
83	175							
124	158							
111	110							
65	160							
110	110							

Table C-7: Capture Data for Downstream Fish Population at Salina Creek Mark and Recapture Site

Salina Downstream							
Latitude:	38.882097						
Longitude:	111.577524	All fish were released 10 meters downstream of the culvert outlet					
Date:	14-Apr-07	Fish standard length was measured and recorded in mm					
Color:	Yellow						
Total Tagged Fish:	206	[fish]					
Individual Specie Totals							
106	19	30	0	48	1	2	0
Leatherside	Mnt. Sucker	Sculpin	Long nose	Speckled	Brown	Cutthroat	Rainbow
55	164	73		62	118	293	
89	189	67		63		255	
92	179	60		75			
105	80	63		73			
106	128	62		65			
85	164	96		71			
83	194	65		67			
107	165	84		63			
78	182	72		58			
88	143	68		78			
93	130	75		61			
55	113	64		60			
82	179	64		80			
76	182	67		75			
83	167	64		68			
100	158	62		64			
78	157	62		68			
98	107	67		73			
93	77	67		74			
75		64		77			
104		68		73			
82		67		65			
90		68		57			
66		64		57			
59		60		77			
93		66		75			
100		68		66			
94		69		57			
77		63		57			
122		56		71			
110				63			
97				66			
100				64			
94				64			
104				59			
87				75			
102				79			
95				74			
94				60			
90				66			
92				67			
83				59			
70				61			
79				70			
110				58			
110				71			
100				61			
88				67			
75							
82							
81							
84							
98							
53							
54							
56							
64							
120							
110							
97							
100							
107							
113							

Table C-8: Capture Data for Downstream Fish Population at Daniel's Creek #1 Mark and Recapture Site

Daniel Culvert #1 Downstream							
Latitude:	40.38523	Culvert #1: This Culvert is the furthest downstream of the two culvert sites in this individual study					
Longitude:	111.30221	This tagging represents the area downstream of Culvert #1					
Date:	21-May-07	All fish were released 10 meters downstream of the culvert outlet					
Color:	Green	Fish standard length was measured and recorded in mm					
Total Tagged Fish:	108 [fish]						
Individual Specie Totals							
0	0	87	0	0	18	0	3
Leatherside	Mnt. Sucker	Sculpin	Long nose	Speckled	Brown	Cutthroat	Rainbow
		71			195		156
		75			198		140
		66			98		117
		58			91		
		57			89		
		65			77		
		58			207		
		58			230		
		65			210		
		57			280		
		58			86		
		60			77		
		62			75		
		70			280		
		55			250		
		58			90		
		54			268		
		56			89		
		60					
		69					
		54					
		75					
		63					
		55					
		49					
		35					
		40					
		40					
		35					
		34					
		40					
		51					
		41					
		57					
		55					
		41					
		38					
		38					
		39					
		38					
		58					
		60					
		67					
		54					
		82					
		61					
		56					
		63					
		64					
		65					
		55					
		54					
		59					
		59					
		34					
		40					
		33					
		31					
		82					
		62					
		60					
		58					
		60					

Table C-9: Capture Data for Upstream Fish Population at Daniel's Creek #1 and Downstream Population at Daniel's Creek #2 Mark and Recapture Sites. This is the Transect between These Two Culverts

Daniel Culvert #1 Upstream		Individual Specie Totals							
Latitude:	40.38523	0	0	84	0	0	79	3	4
Longitude:	111.30221	Leatherside	Mnt. Sucker	Sculpin	Long nose	Speckled	Brown	Cutthroat	Rainbow
Date:	21-May-07			66			300	137	145
Color:	Pink			63			250	170	107
Total Tagged Fish:	170 [fish]			68			235	163	132
				65			250		153
				61			265		
				63			270		
				61			120		
				63			105		
				55			87		
				68			108		
				45			86		
				61			230		
				46			232		
				58			270		
				42			218		
				38			260		
				40			250		
				41			250		
				40			230		
				43			263		
				39			225		
				35			225		
				36			193		
				72			222		
				58			255		
				36			202		
				34			270		
				68			300		
				71			105		
				82			252		
				70			210		
				55			100		
				73			95		
				75			105		
				60			112		
				65			109		
				67			110		
				44			109		
				66			87		
				70			100		
				59			85		
				61			90		
				69			90		
				58			100		
				63			83		
				36			230		
				71			220		
				78			260		
				61			254		
				38			270		
				43			265		
				37			235		
				40			265		
				39			270		
				39			87		
				39			220		
				41			240		
				41			102		
				36			285		
				40			250		
				40			245		
				39			250		
				38			240		

Table C-10: Capture Data for Upstream Fish Population at Daniel's Creek #2 Mark and Recapture Site

Daniel Culvert #1 Upstream							
Latitude:	40.38256	Culvert #2: This Culvert is the furthest upstream of the two culvert sites in this individual study					
Longitude:	111.30047	This tagging represents the area upstream of Culvert #2					
Date:	21-May-07	All fish were released 20m upstream of Culvert #2					
Color:	Orange	Fish standard length was measured and recorded in mm					
Total Tagged Fish:	91 [fish]						
Individual Specie Totals							
0	0	49	0	0	36	2	4
Leatherside	Mnt. Sucke	Sculpin	Long nose	Speckled	Brown	Cutthroat	Rainbow
		42			250	61	255
		57			205	155	165
		66			235		115
		65			222		117
		95			91		
		80			98		
		62			100		
		66			88		
		63			96		
		49			76		
		62			153		
		69			213		
		80			198		
		57			252		
		37			280		
		39			268		
		40			225		
		61			220		
		58			245		
		40			257		
		38			257		
		36			230		
		60			235		
		40			255		
		35			109		
		40			83		
		36			215		
		29			250		
		41			275		
		41			196		
		35			245		
		41			86		
		58			112		
		58			200		
		35			87		
		40			101		
		38					
		39					
		41					
		39					
		40					
		37					
		36					
		41					
		39					
		36					
		34					
		35					
		36					

Table C-11: Recapture Data for Downstream Transect at Soldier Creek Mark and Recapture Site

SOLDIER LOWER TRANSECT														
Culvert Length:	183.0	[m]	Transects starts at culvert inlet and move downstream in with 10m increments beginning at the culvert outlet											
Latitude:	39.99365													
Longitude:	111.493941													
Date:	6-Aug-07		BOLD values indicate the tag color (g or y) and standard length of recaptured individuals											
Lower Transect Color:	Yellow (y)													
Upper Transect Color:	Green (g)		Segments: Integers represent total number of species (captured and recaptured) for that segment											
Total Recaptured Fish:	22	[fish]												
			Individual Specie Totals Channel A						Individual Specie Totals Side Channel B					
Transect	260	287	70	90	0	10	0	0	0	0	0	0		
	Leatherside	Mnt. Sucker	Sculpin	Longnose	Speckled	Brown	Cutthroat	Rainbow						
Culvert Inlet														
170m from outlet	131	112	15	8										
150m from outlet	y/77		y/74											
130m from outlet			y/82											
100m from outlet			y/91											
Culvert Outlet														
0 - 10m		7	5											
10 - 20m	9	3	2											
			g/89											
20 - 30m	12	31	8	11										
			y/85											
30 - 40m	9	33	11	12		3								
			y/76	y/80										
40 - 50m	17	30	9	16		4								
	y/88	y/110	y/81											
50 - 60m	27	21	11	10		1								
			y/85	g/76										
			y/90											
			y/79											
60 - 70m	5	9	2	6										
			y/95											
70 - 80m		1	1	9		1								
		y/98												
80 - 90m	2	16	2	2										
90 - 100m	39	39	4	31										
	y/97	y/152												
100 - 110m	18	24	4	17										
110 - 120m	11	4	3	4		1								
120 - 130m	10	1	1											
130 - 140m	6	1	1	4		1								
140 - 150m		1	3											
150 - 160m	3	2	2											
		g/110												

Table C-12: Recapture Data for Upstream Transect at Soldier Creek Mark and Recapture Site

SOLDIER UPPER TRANSECT								
Culvert Length:	183.0	[m]						Transects begin at culvert inlet and move upstream in 10 meter increments
Latitude:	39.99365							BOLD values indicate the tag color (g or y) and standard length of recaptured individuals
Longitude:	111.493941							
Date:	7-Aug-07							
Lower Transect Color:	Yellow (y)							Segments: Integers represent total number of species (captured and recaptured) for that segment
Upper Transect Color:	Green (g)							
Total Recaptured Fish:	24	[fish]						
Total Collected Individual Species								
	106	320	137	370	0	12	2	
Transect	Leatherside	Mnt. Sucker	Sculpin	Longnose	Speckled	Brown	Cutthroat	
Culvert Inlet								
0 -10m	8	4	8	29		2	1	
10 - 20m	1	19 g/155 g/92	4	42 g/74				
20 - 30m		14 g/146	10 g/72 g/79 g/70	28 g/84		2		
30 - 40m		14 y/125 g/124	12 g/70	26 g/78				
40 - 50m		31	6	34 g/74 g/76 g/74			1	
50 - 60m	4 y/79	50	10	43 g/76				
60 - 70m	1	37	4	14		1		
70 - 80m		34	4	24				
80 - 90m	1	30	4	8		1		
90 - 100m	3	1 g/150		1				
100 - 110m	16 y/104 y/73	13	6	8				
110 - 120m	14	14 g/119	10 g/58	19				
120 - 130m	8	17	12	15		1		
130 - 140m	15 y/90	4	10	5				
140 - 150m	5	2	8	4		1		
150 - 160m		3	5	12		1		
160 - 170m	2	6	4	6				
170 - 180m	2	8	5	14				
180 - 190m	17	8	8	7				
190 - 200m	9	11	7 g/65	31		3		

Table C-13: Recapture Data for Downstream Transect at Diamond Fork #1 Mark and Recapture Site

DIAMOND LOWER TRANSECT						
Culvert Length:	50.0	[m]				
Latitude:	40.027183					
Longitude:	111.50349					
Date:	13/10/2007					
Lower Transect Color:	Orange (o)					
Middle Transect Color:	Pink (p)					
Upper Transect Color:	Green (g)					
Total Recaptured Fish:	2	[fish]				
			Transects begins at Culvert #1 Outlet and moves downstream in 10m increments to the Spanish Fork River confluence			
			BOLD values indicate the tag color (g, p or y) and standard length of recaptured individuals			
			Segments: Integers represent total number of species (captured and recaptured) for that segment			
Total Collected Individual Species						
	0	2	4	18	0	13
Transect	Leatherside	Mnt. Sucker	Sculpin	Longnose	Brown	Cutthroat
Culvert #1 Outlet						
10-0m	10 o/245		99	6	3	
20-10m			21			
30-20m			42	1	3	
40-30m			17	4	1	
50-40m		1	18 o/84			
60-50m		1	14	3	1	
70-60m			26		1	
80-70m			9	1	2	1
90-80m			8		2	
100-90m			26	1	2	
110-100m		1	11	1		
120-110m			40		5	
130-120m			20			
140-130m	1		56	1	3	2
150-140m			13		1	
160-150m			10		2	
170-160m			30		8	
180-170m		1	41	1		

Table C-14: Recapture Data for Middle Transect Between Diamond Fork #1 and Diamond Fork #2 Mark and Recapture Sites

DIAMOND MIDDLE TRANSECT						
Culvert Length:	50.0	[m]				
Latitude:	40.027183					
Longitude:	111.50349					
Date:	13/10/2007					
Lower Transect Color:	Orange (o)					
Middle Transect Color:	Pink (p)					
Upper Transect Color:	Green (g)					
Total Recaptured Fish:	1	[fish]				
			Transect begins at Culvert #2 outlet and moves downstream in 10m segments			
			BOLD values indicate the tag color (g, p or y) and standard length of recaptured individuals			
			Segments: Integers represent total number of species (captured and recaptured) for that segment			
Total Collected Individual Species						
	0	0	2	0	0	0
Segment	Leatherside	Mnt. Sucker	Sculpin	Longnose	Brown	Cutthroat
Culvert #2 Outlet						
10-0m			2 p/84			
10-20m						

Table C-15: Recapture Data for Upstream Transect at Diamond Fork #2 Mark and Recapture Site

DIAMOND UPPER TRANSECT						
Culvert Length:	179.9	[m]	Transect begins at Culvert #2 inlet and moves upstream in 10m segments			
Latitude:	40.027183					
Longitude:	111.50349					
Date:	13/10/2007					
Lower Transect Color:	Orange (o)		BOLD values indicate the tag color (g, p or y) and standard length of recaptured individuals			
Middle Transect Color:	Pink (p)					
Upper Transect Color:	Green (g)					
Total Recaptured Fish:	5	[fish]	Segments: Integers represent total number of species (captured and recaptured) for that segment			

Transect	Total Collected Individual Species					
	Leatherside	Mnt. Sucker	Sculpin	Longnose	Brown	Cutthroat
Culvert #2 Inlet						
0-10m		4	11		1	
10-20m		3	6	1		
20-30m			8	1	4	
30-40m			1			
40-50m		9 g/71	45	4		
50-60m		2	9	1		
60-70m			17			
70-80m			22			
80-90m			28			
90-100m		1	54			
100-110m						
110-120m						
120-130m						
130-140m						
140-150m					3 g/350 g/350	
150-160m					3 g/350 g/310	
160-170m			1			
170-180m					1	
180-190m						
190-200m		1	2		14	

Table C-16: Recapture Data for Downstream Transect at Salina Creek Mark and Recapture Site

SALINA DOWNSTREAM						
Culvert Length:	77.9	[m]				
Latitude:	38.882097					
Longitude:	111.577524					
Date:	14-Aug-07		Transects begin at culvert outlet and moved downstream in 10 meter increments			
Lower Transect Color:	Yellow		BOLD values indicate the tag color (p or y) and standard length of recaptured individuals			
Upper Transect Color:	Pink					
Total Recaptured Fish:	50	[fish]	Segments: Integers represent total number of species (captured and recaptured) for that segment			

Segments	Total Collected Individual Species					
	407	206	352	693	8	3
Culvert Outlet	Sculpin	Mt. Sucker	Leaterside	S. Dace	Brown	Cutthroat
0 - 10m	7	9	30 y/98 y/102 y/88 y/87	20	6 p/285	1
10 - 20m	19	8	58 y/105 y/105 y/77 y/102 y/91 p/91	32		
20 - 30m	27 y/64 y/70	5	26 y/126 y/106 y/92 y/80 y/91	47 y/83 y/73		
30 - 40m	12 y/64	5 y/90	27 y/91 y/86 y/109 y/97 y/92 y/100 y/95 y/95 y/99 y/102	27 y/61		

Segments	Sculpin	Mt. Sucker	Leaterside	S. Dace	Brown	Cutthroat
40 - 50m	54 y/62	6 y/99	1	22 y/82 y/72 y/61		
50 - 60m	1	9 p/15	34 y/114 y/112 y/102 y/97 y/89	18 y/66		
60 - 70m	24	4	5	30		1
70 - 80m	32	2	1	14		
80 - 90m	44	13		72		
90 - 100m	23	11	21 y/91	51		
100 - 110m	22	16	27	84		
110 - 120m	24	24	8	36		1
120 - 130m	48	8 y/177	13	39		
130 - 140m	25	23	26	53 y/79		
140 - 150m	9	18	22	30 y/60	2	
150 - 160m	16	4	22 y/103	29		
160 - 170m	11	8	10	7		
170 - 180m	12	17	52 y/85	36		
180 - 190m	6	11	6	32		
190 - 200m	3	22	15	50		

Table C-17: Recapture Data for Upstream Transect at Salina Creek Mark and Recapture Site

SALINA UPPER TRANSECT							
Culvert Length:	77.9	[m]					
Latitude:	38.882097						
Longitude:	111.577524						
Date:	14-Aug-07						
Lower Transect Color:	Yellow						
Upper Transect Color:	Pink						
Total Recaptured Fish:	63	[fish]					
Transects begin at culvert inlet and move upstream in 10 meter increments							
BOLD values indicate the tag color (p or y) and standard length of recaptured individuals							
Segments: Integers represent total number of species (captured and recaptured) for that segment							
Total Collected Individual Species							
Segments	135	230	127	188	11	9	1
Segments	Sculpin	Mt. Sucker	Leatherside	S. Dace	Brown	Cutthroat	Rainbow
Culvert Inlet							
0 - 10m	3	29 p/156 p/138 p/136 p/154 p/134 y/128	5	14 p/80 p/84			
10 - 20m	7	8		14 p/78			1 p/280
20 - 30m	6	6 p/171 p/165		3 p/67		1	
30 - 40m	7	8 p/195	2	18 p/75 p/83 p/73	1		
40 - 50m	5	8 p/162 p/178	1 p/112	2			
50 - 60m	1	30 p/184 p/204 p/170 p/141	25 p/95 p/94 p/100 p/88 p/91 p/101 p/95	15	4		
60 - 70m	10 p/85	4 p/183 p/132	3	7 p/70			
70 - 80m	12						
80 - 90m	4	6 p/116		1			
90 - 100m	4	10 p/113		8 p/131 p/81		11	1 p/165 5 p/275
100 - 110m	8	10 p/173		35 p/101 p/106 p/131 p/120 p/98 p/75 p/84		7	2 1
110 - 120m	1	2		5		2	1 p/273
120 - 130m	10	1				1	
130 - 140m	17 p/74	4		4 p/92		15	1
140 - 150m	2	27 p/135		12 p/135		16 p/91	
150 - 160m	6	15 p/135				7	1
160 - 170m	6	20		19 p/111 p/110 p/83		17	1
170 - 180m	13	9		1		6	1
180 - 190m	11	1				6	
190 - 200m	2	9		1		5	

Table C-18: Recapture Data for Downstream Transect of Daniel's Creek #1 Mark and Recapture Site

DANIELS LOWER TRANSECT				
Culvert Length:	27.4	[m]		
Latitude:	40.38523		Transects begins at the Culvert #1 inlet and moves downstream in 10 m segments beginning at the Culvert #1 outlet	
Longitude:	111.30221			
Date:	9-Aug-07			
Lower Transect Color:	Green (g)		BOLD values indicate the tag color (g, p or o) and standard length of individual recaptured species	
Middle Transect Color:	Pink (p)			
Upper Transect Color:	Orange (o)			
Total Recaptured Fish:	174	[fish]	Segments: Integers represent total number of species (captured and recaptured) for that segment	

Segments	Total Collected Individual Species			
	Sculpin	Brown	Cutthroat	Rainbow
Culvert #1 Inlet				
	2	12		
Culvert #1 Outlet				
0 - 10m	11 g/68 g/79 g/55	4		
10 - 20m	2	2		
20 - 30m	4	3		
*30 - 40m				
*40 - 50m				
50 - 60m		3	1	
60 - 70m	1	3	3	1
70 - 80m		1		
80 - 90m		2 o/255		
90 - 100m		7	1	
100 - 110m	1	1		
110 - 120m	1	6		
120 - 130m	5	7 g/260 g/280		
130 - 140m	3	7		
140 - 150m	10	8		
150 - 160m	5	5		
160 - 170m	5	6		
170 - 180m	3	9 g/310		
180 - 190m	4	10		
190 - 200m	6	9		

Table C-19: Recapture Data for Middle Transect of Daniel's Creek #1 and #2 Mark and Recapture Site

DANIELS MIDDLE TRANSECT				
Culvert Length:	27.4	[m]	Transects begins at the Culvert #1 Inlet and moves upstream in 10m segments ending at the Culvert #2 outlet	
Latitude:	40.38523			
Longitude:	111.30221			
Date:	9-Aug-07		BOLD values indicate the tag color (g, p or o) and standard length of individual recaptured species	
Lower Transect Color:	Green (g)			
Middle Transect Color:	Pink (p)			
Upper Transect Color:	Orange (o)			
Total Recaptured Fish:	39	[fish]	Segments: Integers represent total number of species (captured and recaptured) for that segment	

Segment	Total Collected Individual Species			
	170	174	2	1
	Sculpin	Brown	Cutthroat	Rainbow
Culvert #1 Inlet				
0 -10m	5	2		1
10 - 20m	1	4 g/131 g/136		
20 - 30m	10	1		
30 - 40m	5	6 g/136		
40 - 50m	2	2 p/256		
50 - 60m	1 g/68			
60 - 70m	1	3 p/265 p/242	1	
70 - 80m		2 p/256	1	
80 - 90m	6	11 p/278 p/315 p/255 p/300		
90 - 100m	6 g/72	9		
100 - 110m	2	5 g/236		
110 - 120m	4	7 p/278		
120 - 130m	7	9		
130 - 140m	4	7		

Segment	Sculpin	Brown	Cutthroat	Rainbow
140 - 150m	9	8 p/241 p/246 p/236		
150 - 160m	4	8 p/244		
160 - 170m	9	8		
170 - 180m	4	8 p/286 p/276 p/239 p/279		
180 - 190m	6	10		
190 - 200m	4	6 p/287 p/256		
200 - 210m	1	1 p/239		
210 - 220m	4	3		
220 - 230m	5	5 p/250		
230 - 240m	8	4 p/243		
250 - 260m	10	4		
260 - 270m	9	3		
270 - 280m	5	15 p/215 p/289 p/273 p/230 p/272		
280 - 290m	16	7		
290 - 300m	15 p/75	8		
300 - 310m	7	8 p/157 p/146 p/157 p/131 p/214		
Culvert #2 Outlet				

Table C-20: Recapture Data for Upstream Transect of Daniel's Creek #2 Mark and Recapture Site

DANIELS UPPER TRANSECT				
Culvert Length:	28.7	[m]		
Latitude:	40.38256		Transects begins at the Culvert #2 Outlet and moves upstream in 10m segments beginning at the Culvert #2 inlet	
Longitude:	111.30047			
Date:	13-Aug-07			
Lower Transect Color:	Green (g)		BOLD values indicate the tag color (g, p or o) and standard length of individual recaptured species	
Middle Transect Color:	Pink (p)			
Upper Transect Color:	Orange (o)			
Total Recaptured Fish:	52	[fish]	Segments: Integers represent total number of species (captured and recaptured) for that segment	

Segment	Total Collected Individual Species			
	53	81	7	2
Segment	Sculpin	Brown	Cutthroat	Rainbow
Culvert #2 Outlet	2	12		
Culvert #2 Inlet				
10m		p/138 p/117 p/143		
20m		p/149 p/246 p/230 o/272 o/278 o/266 o/265		
0 -10m	5 o/56 p/52	10 o/245 o/127 p/250 p/157 p/145		
10 - 20m	2	3 o/120		
20 - 30m		2 p/278		
30 - 40m	1	4 o/141 o/140		
40 - 50m	5	7		
50 - 60m	3	10 o/262 o/265 o/247 o/245 o/123 o/268 o/116 o/237 o/247	3 o/172 o/180	1 o/250

Segment	Sculpin	Brown	Cutthroat	Rainbow
60 - 70m	1	4 o/271 o/226 p/249	1	
70 - 80m	4	5 o/225 o/122	1 p/167	
80 - 90m		6 o/228 o/256 o/154 o/224 o/228 p/135	1	
90 - 100m	4	4 o/248 o/254	1 p/168	
100 - 110m	6		1 o/168	
110 - 120m	4	6		
120 - 130m	2	1		1
130 - 140m	2	2		
140 - 150m	3	4 o/276 p/242		
150 - 160m	4 o/73	1		
160 - 170m	3	2		
170 - 180m				
180 - 190m	1	3		
190 - 200m	1	3		

Fish Passage Assessment Data

CULVERT DATABASE ID#: _____ (Assigned by UDOT ETS)

FISH PASSAGE ASSESSMENT FIELD DATA SHEET

Surveyor Names: Aaron Beavers, Shawn Stanley Field Date: 3/21/08

SITE

Barrels: 1 Barrel #: 1 of 1

UDOT Region: _____ Route #: 40 Milepost #: _____ Stream Name: Daniels Creek (up)

GPS: (Lat): 40.38256° (Long): 111.30047 Coordinate System: WSG 84 Units: degrees

PHOTOS: Provide Photo #'s, Locations, and Shot Orientation in Sketch

(1) Embankment Looking Upstream (2) Embankment Looking Downstream

(3) Looking at Outlet to include Outlet Control (4) Internal Culvert Structures (5) Slope Break in Culvert

(6) Looking at Inlet from 25 ft (7) Instream Structures (8) Bank Stabilization Structures (9) Local Erosion

(10) Local Failures (11) Channel Incision (12) Channel Aggradation (13) Other: _____

CULVERT DATA:

Physical: Length: 94 (ft) Rise: _____ (ft) Span: _____ (ft) Diameter: 6.5 (ft)

Scour width: 18' (ft) Scour length: 32' (ft)

Corrugation (height): 2 (in.) (width): 6 (in.)

Material: Steel Aluminum PVC HDPE Concrete Other: _____

Shape: Box Circular Pipe Pipe-arch (Squash Pipe) Horizontal Ellipse Arch Arch Box

Roughness: Smooth Corrugated Annular Corrugated Spiral Plated Paved Baffles Slope Breaks

Inlet: Projected Mitered Headwall Wingwall (10-30 Deg) Wingwall (30-70 Deg) Apron Embedded

Inlet Edge Conditions: Grooved Edge Square Edge Beveled Edge

Outlet: At stream grade Perched Cascade Freefall Apron RipRap Embedded

Hydraulic Jump: Absent Present

Hydraulic Jump Location: Inlet Outlet Upper 3rd Middle 3rd Lower 3rd

SUBSTRATE DATA: Provide Substrate Characteristics and Geometry in Sketch

Condition: Absent Continuous Discontinuous Patchy

Inlet: Absent Present Outlet: Absent Present

Observed Size: Boulders Cobble Gravel Sand Fines

Notes: Several large boulders located in the first 10ft inside the culvert inlet. Cobble begins at this point and continuous to the outlet. Gravel size substrate can be found near the outlet.

Hydraulic jump occur approximately 40ft downstream of the inlet.

Assessment Duration: 48 min

1

Figure C-1: Page 1 of Fish Passage Assessment of Daniel's Creek #2 Culvert

LONGITUDINAL SURVEY DATA

Benchmark: Inlet Invert Outlet Invert Rod Height: 5 (ft)

Channel

Station	BS (+)	HI	FS(+)	Horizontal	Elev	Notes	Nomenclature
1	-7.52	66.5"					BM = Benchmark
2	-8.76						TP = Turning Point
4a	1.36						CC = Culvert Ceiling
4b	-1.96	49.25"	10.775			TP BM	SB = Stream Bed
5	2.32						I = Invert
6	0.23						RS = Road Surface
7	0.72						S = Slope Break
8	0.72						A = Apron
9	1.0						LB = Left Bank
10	0.415						RB = Right Bank
							Additional

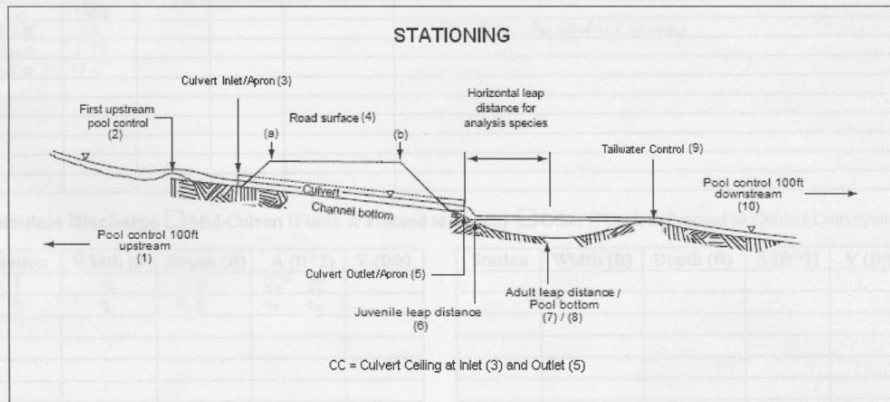

Figure 1. Longitudinal Profile Stations (Modified USFS Photo Clarkin et al)

Horizontal Distances
 d(1)_{1→2}: 81 (ft) d(2)_{2→3}: 17 (ft) d(3)_{3→5}: 94 (ft) d(4)_{9→10}: 64 (ft)

Figure C-2: Page 2 of Fish Passage Assessment of Daniel's Creek #2 Culvert



FIELD CALCULATIONS

Culvert Slopes: Invert Slope $_{3 \rightarrow 5}$: 1.69 (%) Ceiling Slope $_{3Top \rightarrow 5Top}$: _____ (%)

Inlet/Outlet Depth/Drop: Residual Inlet Depth: -1.32 (ft) Outlet Drop: -0.27 (ft)

Culvert Length/Slope Product: Culvert Length (ft) X Culvert Slope (%): 159 (ft)

Scour Hole to Culvert Width: 2.78 (ft/ft)

CULVERT FISH PASSAGE STATUS

ADULT SALMONID STATUS: RED GREEN GREY

JUVENILE SALMONID STATUS: RED GREEN GREY

CYPRINIDAE STATUS: RED GREEN GREY

SMALL BENTHIC STATUS: RED GREEN GREY

HYDRAULIC CALIBRATION (Only Perform for Passage Status of GREY when Baffles are NOT Present)

Tailwater Cross Section Looking upstream to Point 9: Stationing is from Left bank to Right bank

Station	BS (+)	HI	FS(+)	Elevation	Notes
0	4.64				
6	2.4				
11	1.92				
17	1.65				
23.5	1.0				P9 from longitudinal survey
28.0	1.92				
28.0	4.5				

Calculate Discharge Mid-Culvert (Finish & Proceed to Sketch) Other (Finish & Proceed to Culvert Conveyance)

Station	Width (ft)	Depth (ft)	A (ft^2)	V (ft/s)
1	2	1.0	2.0 2.5 3.0	
2	2	0.8	2.0 3.0	

Station	Width (ft)	Depth (ft)	A (ft^2)	V (ft/s)

Figure C-3: Page 3 of Fish Passage Assessment of Daniel's Creek #2 Culvert



CULVERT CONVEYANCE

Standard Culvert Conveyance CSA

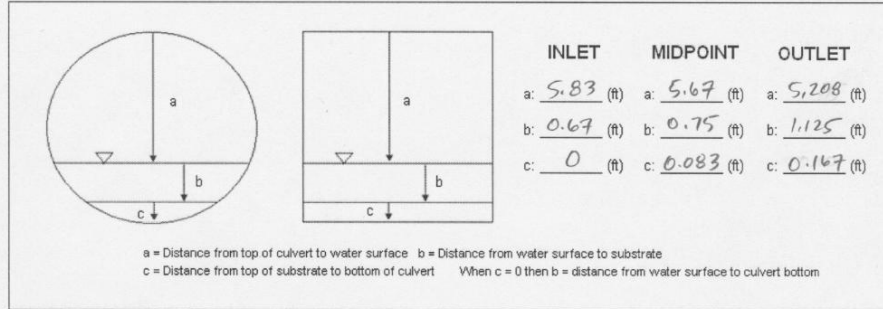

The depth at (c) can be solved for by subtracting (a) and (b) from a known culvert diameter or rise. If the culvert is sufficiently embedded at the inlet and outlet, and the depth at (c) cannot be easily obtained; notate (c) as "NA".

Notes: _____

BAFFLE SKETCH:





- Top View Orientation
- Horizontal Side View Orientation
- Horizontal Cross Sectional View Orientation
- Baffle Angles
- Distance Between Baffles (Spacing)
- Baffle Pattern
- Baffle Height

Figure C-4: Page 4 of Fish Passage Assessment of Daniel's Creek #2 Culvert

Note Summary/Heading Comments/Descriptions/Photo #'s/Other: Culvert is backwatered from hydraulic jump downstream to the culvert outlet. Retaining wall is 6-8 ft high relative to stream bed.

SKETCH:

North Arrow
 Direction of Stream Flow
 Culvert/Channel/Road Alignment
 Photo Locations with number
 Cross Section Locations
 Wingwall/Apron Configuration
 Structures:
 Internal
 Instream
 Stabilization

-  - wing wall
-  - retaining wall
-  - rip rap
-  - large boulders
-  - substrate in culvert

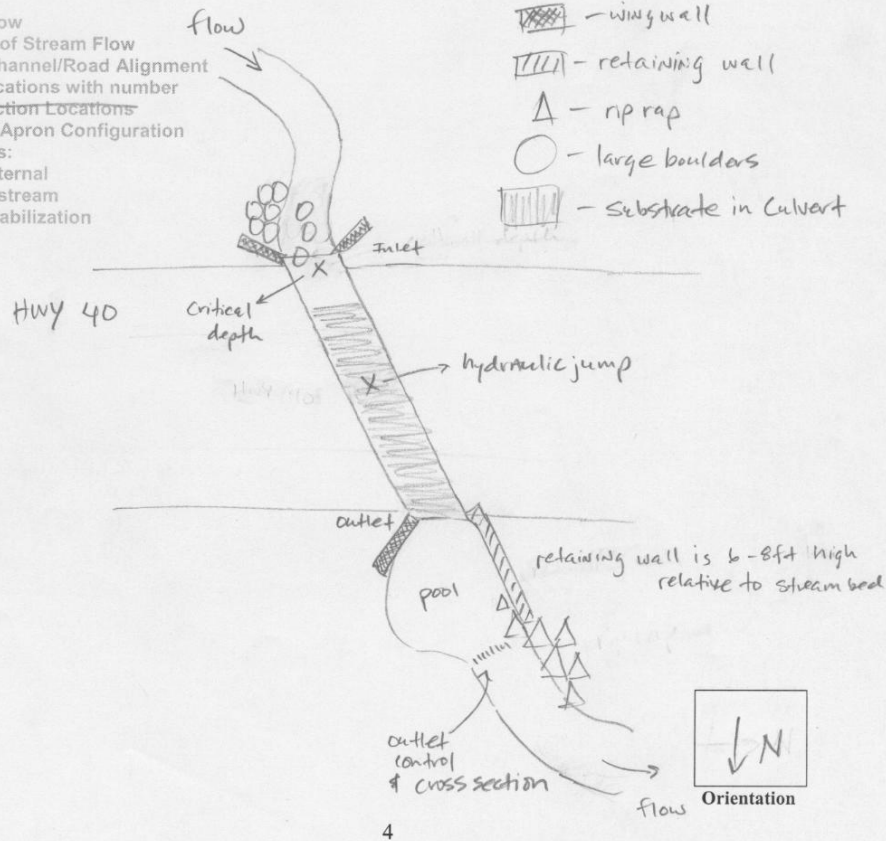

Figure C-5: Page 5 of Fish Passage Assessment of Daniel's Creek #2 Culvert

CULVERT DATABASE ID#: _____ (Assigned by UDOT ETS)

FISH PASSAGE ASSESSMENT FIELD DATA SHEET

Surveyor Names: Aaron Beavers, Shawn Stanley Field Date: 3/22/08

SITE

Barrels: 1 Barrel #: 1 of 1

UDOT Region: _____ Route #: 89 Milepost #: _____ Stream Name: Soldier Creek

GPS: (Lat): 39.99365 (Long): 111.493941 Coordinate System: NSG 84 Units: degrees

PHOTOS: Provide Photo #'s, Locations, and Shot Orientation in Sketch

- (1) Embankment Looking Upstream (2) Embankment Looking Downstream
 (3) Looking at Outlet to include Outlet Control (4) Internal Culvert Structures (5) Slope Break in Culvert
 (6) Looking at Inlet from 25 ft (7) Instream Structures (8) Bank Stabilization Structures (9) Local Erosion
 (10) Local Failures (11) Channel Incision (12) Channel Aggradation (13) Other: _____

CULVERT DATA:

Physical: Length: 600 (ft) Rise: _____ (ft) Span: _____ (ft) Diameter: 17.5 (ft)

Scour width: 24 (ft) Scour length: _____ (ft)

Corrugation (height): 2 (in.) (width): 6 (in.)

Material: Steel Aluminum PVC HDPE Concrete Other: _____

Shape: Box Circular Pipe Pipe-arch (Squash Pipe) Horizontal Ellipse Arch Arch Box

Roughness: Smooth Corrugated Annular Corrugated Spiral Plated Paved Baffles Slope Breaks

Inlet: Projected Mitered Headwall Wingwall (10-30 Deg) Wingwall (30-70 Deg) Apron Embedded

Inlet Edge Conditions: Grooved Edge Square Edge Beveled Edge

Outlet: At stream grade Perched Cascade Freefall Apron RipRap Embedded

Hydraulic Jump: Absent Present

Hydraulic Jump Location: Inlet Outlet Upper 3rd Middle 3rd Lower 3rd

SUBSTRATE DATA: Provide Substrate Characteristics and Geometry in Sketch

Condition: Absent Continuous Discontinuous Patchy

Inlet: Absent Present Outlet: Absent Present

Observed Size: Boulders Cobble Gravel Sand Fines

Notes: Substrate begins 30ft inside culvert inlet and is continuous for the length of the culvert to the outlet. The outlet is embedded in fines

Assessment Duration: 32 min

793-320

Figure C-6: Page 1 of Fish Passage Assessment of Soldier Creek Culvert

FIELD CALCULATIONS

Culvert Slopes: Invert Slope $_{3 \Rightarrow 5}$: 0.267 (%) Ceiling Slope $_{3Top \Rightarrow 5Top}$: _____ (%)

Inlet/Outlet Depth/Drop: Residual Inlet Depth: 0.674 (ft) Outlet Drop: -2.27 (ft)

Culvert Length/Slope Product: Culvert Length (ft) X Culvert Slope (%): 159.7 (ft)

Scour Hole to Culvert Width: 1.37 (ft/ft)

CULVERT FISH PASSAGE STATUS

ADULT SALMONID STATUS: RED GREEN GREY

JUVENILE SALMONID STATUS: RED GREEN GREY

CYPRINIDAE STATUS: RED GREEN GREY

SMALL BENTHIC STATUS: RED GREEN GREY

HYDRAULIC CALIBRATION (Only Perform for Passage Status of GREY when Baffles are NOT Present)

Tailwater Cross Section Looking upstream to Point 9: Stationing is from Left bank to Right bank

Station	BS (+)	HI	FS(+)	Elevation	Notes

Calculate Discharge Mid-Culvert (Finish & Proceed to Sketch) Other (Finish & Proceed to Culvert Conveyance)

Station	Width (ft)	Depth (ft)	A (ft^2)	V (ft/s)

Station	Width (ft)	Depth (ft)	A (ft^2)	V (ft/s)

Figure C-8: Page 3 of Fish Passage Assessment of Soldier Creek Culvert

CULVERT CONVEYANCE

Standard Culvert Conveyance CSA

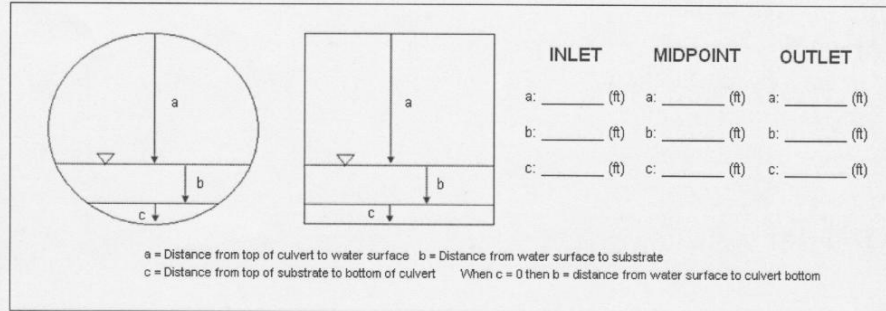

The depth at (c) can be solved for by subtracting (a) and (b) from a known culvert diameter or rise. If the culvert is sufficiently embedded at the inlet and outlet, and the depth at (c) cannot be easily obtained; notate (c) as "NA".

Notes: _____

BAFFLE SKETCH:

- Top View Orientation
- Horizontal Side View Orientation
- Horizontal Cross Sectional View Orientation
- Baffle Angles
- Distance Between Baffles (Spacing)
- Baffle Pattern
- Baffle Height

Figure C-9: Page 4 of Fish Passage Assessment of Soldier Creek Culvert

SKETCH:

- North Arrow
- Direction of Stream Flow
- Culvert/Channel/Road Alignment
- Photo Locations with Number and Orientation Arrow
- Cross Section Locations
- Baffle dimensions/locations
- Hydraulic Jump
- Head/Wingwall/Apron Configuration
- Rip Rap
- Slope Breaks
- Other Structures
- Substrate Details

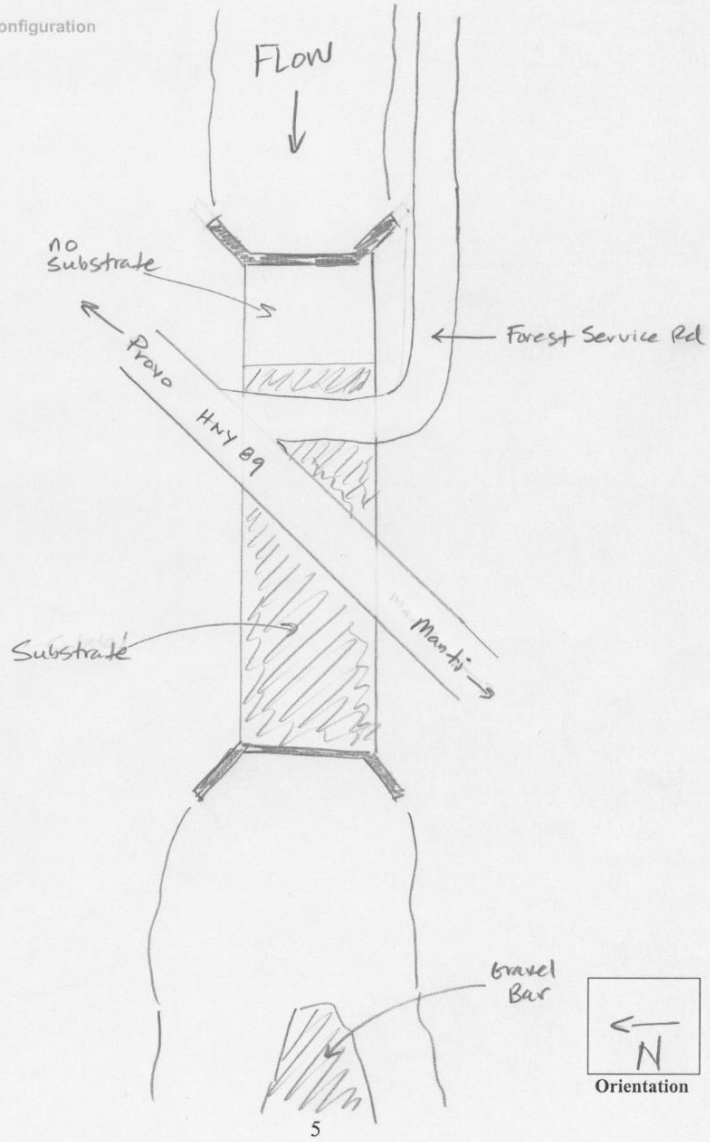

Figure C-10: Page 5 of Fish Passage Assessment of Soldier Creek Culvert

CULVERT DATABASE ID#: _____ (Assigned by UDOT ETS)

FISH PASSAGE ASSESSMENT FIELD DATA SHEET

Surveyor Names: Aaron Beavas, Shawn Stanley Field Date: 3/20/08

SITE

Barrels: 1 Barrel #: 1 of 1

UDOT Region: _____ Route #: 70 Milepost #: 73 Stream Name: Salina Creek

GPS: (Lat): 38.882099° (Long): 111.577524° Coordinate System: WGS 80 Units: Decimal Degrees

PHOTOS: Assign Photo #'s, Locations, and Shot Orientation in Sketch

- (1) Embankment Looking Upstream (2) Embankment Looking Downstream
 (3) Looking at Outlet to include Outlet Control (4) Internal Culvert Structures (5) Slope Break in Culvert
 (6) Looking at Inlet from 25 ft (7) Instream Structures (8) Bank Stabilization Structures (9) Local Erosion
 (10) Local Failures (11) Channel Incision (12) Channel Aggradation (13) Other: _____

CULVERT DATA

Physical: Length: 255.6 (ft) Rise: _____ (ft) Span: _____ (ft) Diameter: 14.5 (ft)

Scour width: 10' (ft) Scour length: 30' (ft)

Corrugation (height): 2 (in.) (width): 6 (in.)

Material: Steel Aluminum PVC HDPE Concrete Other: _____

Shape: Box Circular Pipe Pipe-arch (Squash Pipe) Horizontal Ellipse Arch Arch Box

Roughness: Smooth Corrugated Annular Corrugated Spiral Plated Paved Baffles Slope Breaks

Inlet: Projected Mitered Headwall Wingwall (10-30 Deg) Wingwall (30-70 Deg) Apron Embedded

Inlet Edge Conditions: Grooved Edge Square Edge Beveled Edge

Outlet: At stream grade Perched Cascade Freefall Apron RipRap Embedded

Hydraulic Jump: Absent Present

Hydraulic Jump Location: Inlet Outlet Upper 3rd Middle 3rd Lower 3rd

SUBSTRATE DATA

Condition: Absent Continuous Discontinuous Patchy

Inlet: Absent Present Outlet: Absent Present

Observed Size: Boulders Cobble Gravel Sand Fines

Notes: Assessment Duration 52 min

Figure C-11: Page 1 of Fish Passage Assessment of Salina Creek Culvert

LONGITUDINAL SURVEY DATA

Benchmark: Inlet Invert Outlet Invert Rod Height: 5 (ft)

Channel

Station	BS (+)	HI	FS(+)	Horizontal	Elev	Notes	Nomenclature
1	0.667						BM = Benchmark
2	0.45						TP = Turning Point
3	-0.650				104.4	I, BM	CC = Culvert Ceiling
4a	26.02					RS	SB = Stream Bed
4b	24.48					RS	I = Invert
5	-2.02						RS = Road Surface
6	-2.65					Cascade	S = Sag/Break
7	/					Over 6' deep	A = Apron
8	/					Over 6' deep	
9	-4.78						Additional
10	-5.015						

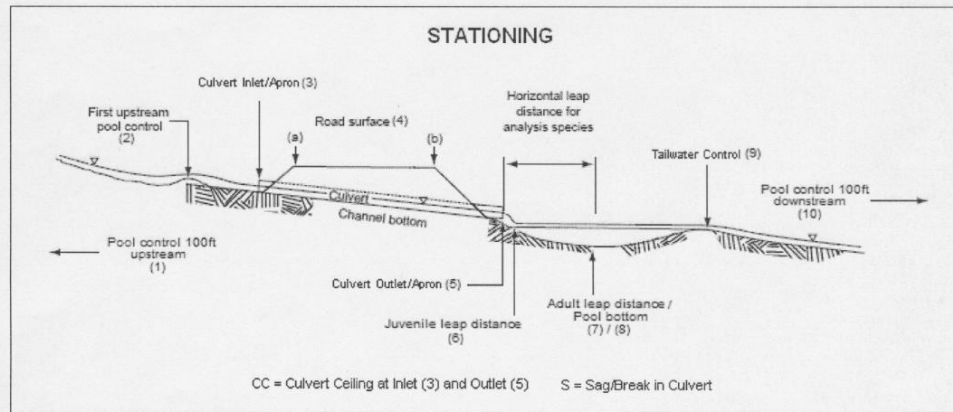

Figure 1. Longitudinal Profile Stations (Modified USFS Photo Clarkin et al)

Horizontal Distances

d(1)_{1→2}: 102.8 (ft) d(2)_{2→3}: 30.2 (ft) d(3)_{3→5}: 255.6 (ft) d(4)_{9→10}: 110.08 (ft)

Figure C-12: Page 2 of Fish Passage Assessment of Salina Creek Culvert

FIELD CALCULATIONS

Culvert Slopes: Invert Slope $_{3 \Rightarrow 5}$: 0.56 (%) Ceiling Slope $_{3Top \Rightarrow 5Top}$: _____ (%)
 Inlet/Outlet Depth/Drop: Residual Inlet Depth: 4.13 (ft) Outlet Drop: 2.7 (ft)
 Culvert Length/Slope Product: Culvert Length (ft) X Culvert Slope (%): 143 (ft)
 Scour Hole to Culvert Width: 0.69 (ft/ft)

CULVERT FISH PASSAGE STATUS

ADULT SALMONID STATUS: RED GREEN GREY

JUVENILE SALMONID STATUS: RED GREEN GREY

CYPRINIDAE STATUS: RED GREEN GREY

SMALL BENTHIC STATUS: RED GREEN GREY

HYDRAULIC CALIBRATION (Only Perform for Passage Status of GREY when Baffles are NOT Present)

Tailwater Cross Section Looking upstream to Point 9: Stationing is from Left bank to Right bank

Station	BS (+)	HI	FS(+)	Elevation	Notes
0	2.17				
5	-4.58				left Bank
6	-4.78				
14	-4.78				
15	-4.58				Right Bank
30	3.78				

Calculate Discharge Mid-Culvert (Finish & Proceed to Sketch) Other (Finish & Proceed to Culvert Conveyance)

Station	Width (ft)	Depth (ft)	A (ft^2)	V (ft/s)
0	0	0	0	rows / sec
0.5	1	1.1	1.1	15 40
1.5	1	1.1	1.1	155 40
2.5	1	0.8	0.8	155 40
3.5	1	0.4	0.4	195 40
4	0	0	0	150 40

Station	Width (ft)	Depth (ft)	A (ft^2)	V (ft/s)

Figure C-13: Page 3 of Fish Passage Assessment of Salina Creek Culvert



CULVERT CONVEYANCE

Standard Culvert Conveyance CSA

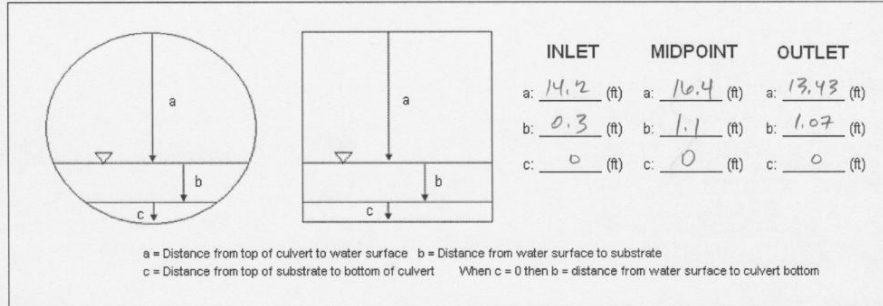

The depth at (c) can be solved for by subtracting (a) and (b) from a known culvert diameter or rise. If the culvert is sufficiently embedded at the inlet and outlet, and the depth at (c) cannot be easily obtained; notate (c) as "NA".

Notes: _____

BAFFLE SKETCH:

- Top View Orientation
- Horizontal Side View Orientation
- Horizontal Cross Sectional View Orientation
- Baffle Angles
- Distance Between Baffles (Spacing)
- Baffle Pattern
- Baffle Height

Figure C-14: Page 4 of Fish Passage Assessment of Salina Creek Culvert

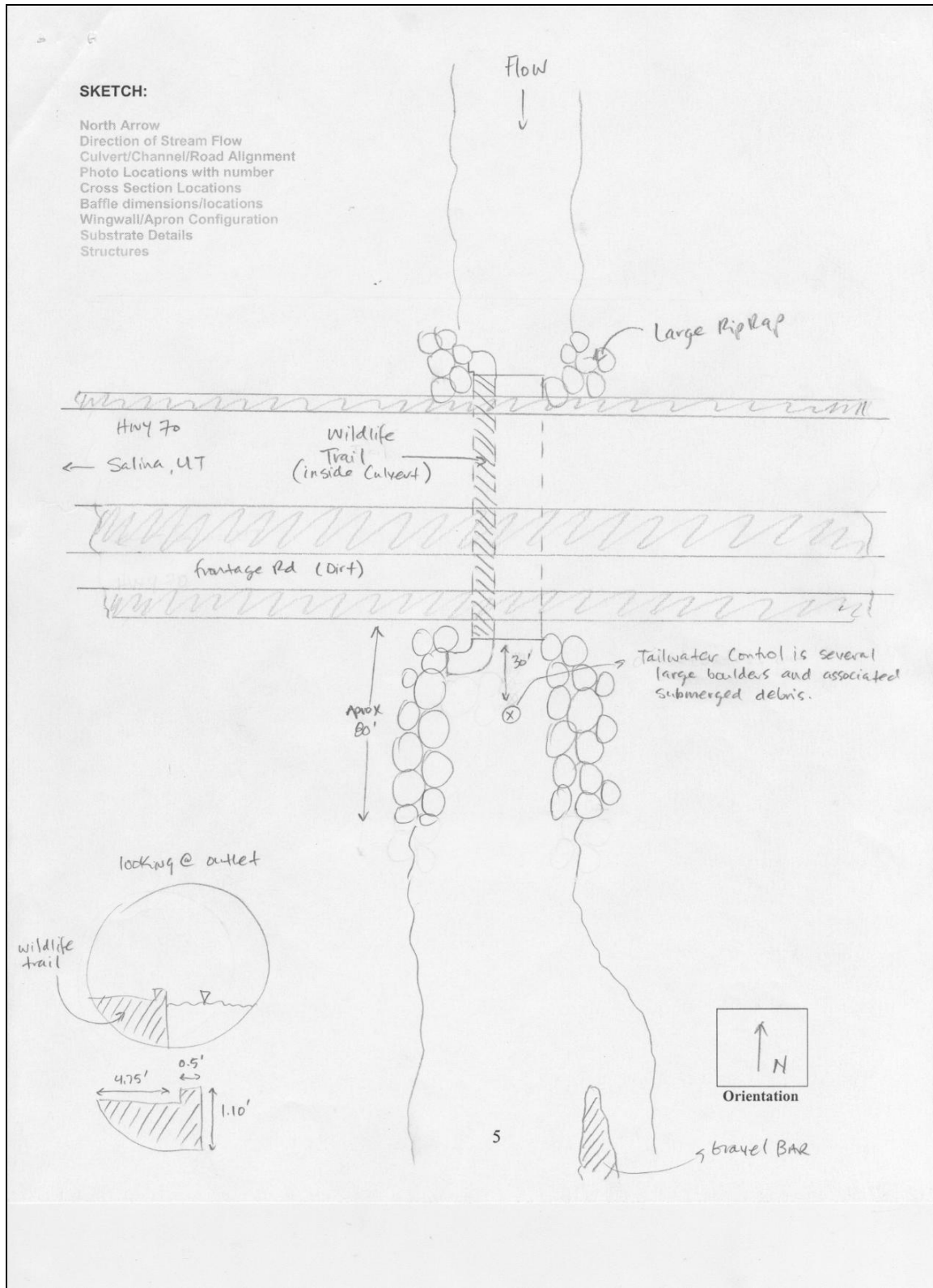

Figure C-15: Page 5 of Fish Passage Assessment of Salina Creek Culvert

CULVERT DATABASE ID#: _____ (Assigned by UDOT ETS)

FISH PASSAGE ASSESSMENT FIELD DATA SHEET

Surveyor Names: Aaron Beavers / Shawn Stanley Field Date: 3/21/09

SITE

Barrels: 1 Barrel #: 1 of 1

UDOT Region: _____ Route #: 40 Milepost #: _____ Stream Name: Daniel's Creek

GPS: (Lat): 40.38523° (Long): 111.30221° Coordinate System: NAD 84 Units: Degrees

PHOTOS: Provide Photo #'s, Locations, and Shot Orientation in Sketch

- (1) Embankment Looking Upstream (2) Embankment Looking Downstream
 (3) Looking at Outlet to include Outlet Control (4) Internal Culvert Structures (5) Slope Break in Culvert
 (6) Looking at Inlet from 25 ft (7) Instream Structures (8) Bank Stabilization Structures (9) Local Erosion
 (10) Local Failures (11) Channel Incision (12) Channel Aggradation (13) Other: _____

CULVERT DATA:

Physical: Length: 90 (ft) Rise: ✓ (ft) Span: ✓ (ft) Diameter: 6.5 (ft)

Scour width: 11 (ft) Scour length: 10 (ft)

Corrugation (height): 2 (in.) (width): 6 (in.)

Material: Steel Aluminum PVC HDPE Concrete Other: _____

Shape: Box Circular Pipe Pipe-arch (Squash Pipe) Horizontal Ellipse Arch Arch Box

Roughness: Smooth Corrugated Annular Corrugated Spiral Plated Paved Baffles Slope Breaks

Inlet: Projected Mitered Headwall Wingwall (10-30 Deg) Wingwall (30-70 Deg) Apron Embedded

Inlet Edge Conditions: Grooved Edge Square Edge Beveled Edge

Outlet: At stream grade Perched Cascade Freefall Apron RipRap Embedded

Hydraulic Jump: Absent Present

Hydraulic Jump Location: Inlet Outlet Upper 3rd Middle 3rd Lower 3rd

SUBSTRATE DATA: Provide Substrate Characteristics and Geometry in Sketch

Condition: Absent Continuous Discontinuous Patchy

Inlet: Absent Present Outlet: Absent Present

Observed Size: Boulders Cobble Gravel Sand Fines

Notes: Substrate begins approx 12-ft inside culvert inlet and continues for
length of culvert to outlet.

Hydraulic jump occurs just at/inside culvert inlet.

Assessment Duration: 36 min

Figure C-16: Page 1 of Fish Passage Assessment of Daniel's Creek #1 Culvert

FIELD CALCULATIONS

Culvert Slopes: Invert Slope $_{3 \Rightarrow 5}$: 0.83 (%) Ceiling Slope $_{3Top \Rightarrow 5Top}$: NA (%)

Inlet/Outlet Depth/Drop: Residual Inlet Depth: 0.235 (ft) Outlet Drop: -0.985 (ft)

Culvert Length/Slope Product: Culvert Length (ft) X Culvert Slope (%): 75 (ft)

Scour Hole to Culvert Width: 1.69 (ft/ft)

CULVERT FISH PASSAGE STATUS

ADULT SALMONID STATUS: RED GREEN GREY

JUVENILE SALMONID STATUS: RED GREEN GREY

CYPRINIDAE STATUS: RED GREEN GREY

SMALL BENTHIC STATUS: RED GREEN GREY

HYDRAULIC CALIBRATION (Only Perform for Passage Status of GREY when Baffles are NOT Present)

Tailwater Cross Section Looking upstream to Point 9: Stationing is from Left bank to Right bank

Station	BS (+)	HI	FS(+)	Elevation	Notes

Calculate Discharge Mid-Culvert (Finish & Proceed to Sketch) Other (Finish & Proceed to Culvert Conveyance)

Station	Width (ft)	Depth (ft)	A (ft ²)	V (ft/s)

Station	Width (ft)	Depth (ft)	A (ft ²)	V (ft/s)

Figure C-18: Page 3 of Fish Passage Assessment of Daniel’s Creek #1 Culvert

CULVERT CONVEYANCE

Standard Culvert Conveyance CSA

		INLET	MIDPOINT	OUTLET
a: _____ (ft)	a: _____ (ft)	a: _____ (ft)		
b: _____ (ft)	b: _____ (ft)	b: _____ (ft)		
c: _____ (ft)	c: _____ (ft)	c: _____ (ft)		

a = Distance from top of culvert to water surface b = Distance from water surface to substrate
 c = Distance from top of substrate to bottom of culvert When c = 0 then b = distance from water surface to culvert bottom

The depth at (c) can be solved for by subtracting (a) and (b) from a known culvert diameter or rise. If the culvert is sufficiently embedded at the inlet and outlet, and the depth at (c) cannot be easily obtained; notate (c) as "NA".

Notes: _____

BAFFLE SKETCH:

- Top View Orientation
- Horizontal Side View Orientation
- Horizontal Cross Sectional View Orientation
- Baffle Angles
- Distance Between Baffles (Spacing)
- Baffle Pattern
- Baffle Height

Figure C-19: Page 4 of Fish Passage Assessment of Daniel's Creek #1 Culvert

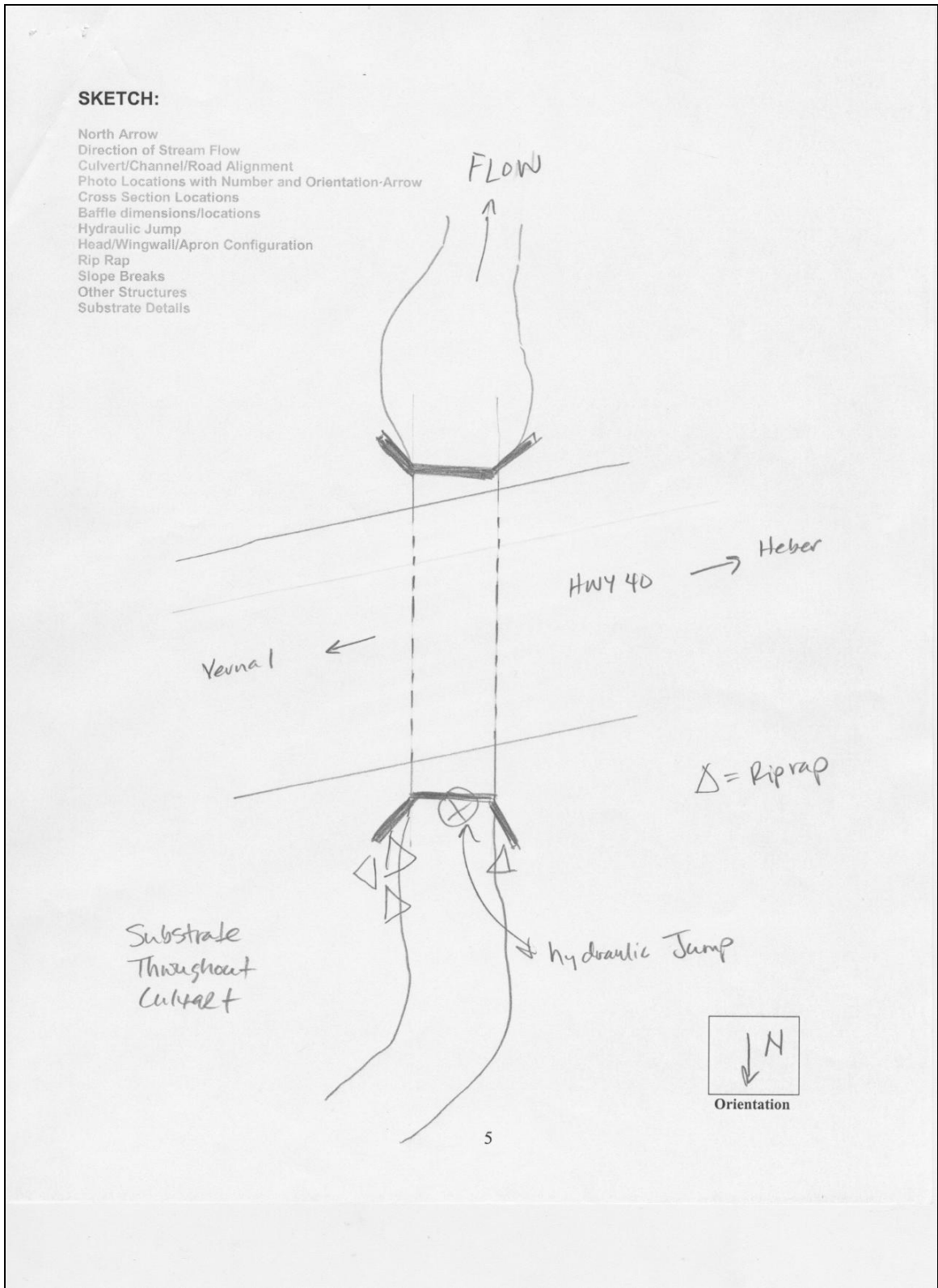

Figure C-20: Page 5 of Fish Passage Assessment of Daniel's Creek #1 Culvert

CULVERT DATABASE ID#: _____ (Assigned by UDOT ETS)

FISH PASSAGE ASSESSMENT FIELD DATA SHEET

Surveyor Names: Aaron Beavas, Ashton Beavas Field Date: 3/22/08

SITE

Barrels: 4 Barrel #: 1 of 4

UDOT Region: _____ Route #: 6 Milepost #: _____ Stream Name: Diamond Fork

GPS: (Lat): 40.027183 (Long): 111.50349 Coordinate System: WGS 84 Units: Degrees

PHOTOS: Provide Photo #'s, Locations, and Shot Orientation in Sketch

- (1) Embankment Looking Upstream (2) Embankment Looking Downstream
- (3) Looking at Outlet to include Outlet Control (4) Internal Culvert Structures (5) Slope Break in Culvert
- (6) Looking at Inlet from 25 ft (7) Instream Structures (8) Bank Stabilization Structures (9) Local Erosion
- (10) Local Failures (11) Channel Incision (12) Channel Aggradation (13) Other: _____

CULVERT DATA:

Physical: Length: 164 (ft) Rise: 12 (ft) Span: 12 (ft) Diameter: _____ (ft)

Scour width: 60 (ft) Scour length: 26 (ft)

Corrugation (height): _____ (in.) (width): _____ (in.)

Material: Steel Aluminum PVC HDPE Concrete Other: _____

Shape: Box Circular Pipe Pipe-arch (Squash Pipe) Horizontal Ellipse Arch Arch Box

Roughness: Smooth Corrugated Annular Corrugated Spiral Plated Paved Baffles Slope Breaks

Inlet: Projected Mitered Headwall Wingwall (10-30 Deg) Wingwall (30-70 Deg) Apron Embedded

Inlet Edge Conditions: Grooved Edge Square Edge Beveled Edge

Outlet: At stream grade Perched Cascade Freefall Apron RipRap Embedded

Hydraulic Jump: Absent Present

Hydraulic Jump Location: Inlet Outlet Upper 3rd Middle 3rd Lower 3rd

SUBSTRATE DATA: Provide Substrate Characteristics and Geometry in Sketch

Condition: Absent Continuous Discontinuous Patchy

Inlet: Absent Present Outlet: Absent Present

Observed Size: Boulders Cobble Gravel Sand Fines

Notes: Substrate found clogging baffles in several places

Assessment Duration 53 min

located under railroad trestle

Figure C-21: Page 1 of Combined Fish Passage Assessment of Diamond Fork #1 & #2 Culverts

LONGITUDINAL SURVEY DATA

Benchmark: Inlet Invert Outlet Invert Rod Height: 5 (ft)

Channel

Culvert #1
Rt
culvert
down
stream

Station	BS (+)	HI	FS(+)	Horizontal	Elev	Notes	Nomenclature
10	-12.255						BM = Benchmark
9	-11.025						TP = Turning Point
8						Too deep/fast unsafe	CC = Culvert Ceiling
7						Too deep/fast unsafe	SB = Stream Bed
6	-11.811						I = Invert
5A	-9.755	-2.575				S = SA	RS = Road Surface
3	-1.585						S = Slope Break
2						Too deep	A = Apron
1	-1.51					Outlet Apron of upstream Culvert	LB = Left Bank
4a	28.05						RB = Right Bank
4b	29.13						
							Additional
5A	-1.51					S = SA	
6						Too deep	
7						Too deep	
8						Too deep	
9	-1.585					Inlet invert downstream Culvert	
4b	90.61					4b apron	
4a	90.61						
3	2.855						
2	2.913						
1	3.543						

Culvert #2
LEFT
culvert
upstream

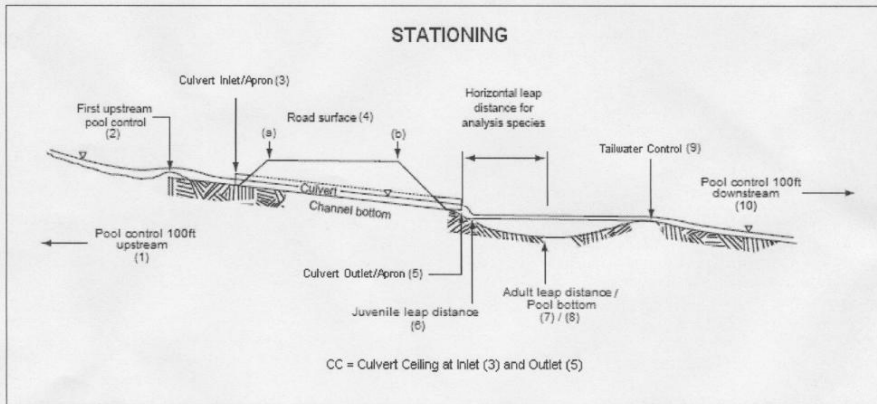

Figure 1. Longitudinal Profile Stations (Modified USFS Photo Clarkin et al)

Horizontal Distances

d(1)_{1→2}: NA (ft) d(2)_{2→3}: NA (ft) d(3)_{3→5}: 164 (ft) d(4)_{9→10}: 222.4 (ft)

Figure C-22: Page 2 of Combined Fish Passage Assessment of Diamond Fork #1 & #2 Culverts

FIELD CALCULATIONS

Culvert Slopes: Invert Slope $_{3\Rightarrow 5}$: 0.604 (%) Ceiling Slope $_{3Top\Rightarrow 5Top}$: _____ (%)
 Inlet/Outlet Depth/Drop: Residual Inlet Depth: _____ (ft) Outlet Drop: _____ (ft)
 Culvert Length/Slope Product: Culvert Length (ft) X Culvert Slope (%): 99 (ft)
 Scour Hole to Culvert Width: _____ (ft/ft)

CULVERT FISH PASSAGE STATUS

ADULT SALMONID STATUS: RED GREEN GREY

JUVENILE SALMONID STATUS: RED GREEN GREY

CYPRINIDAE STATUS: RED GREEN GREY

SMALL BENTHIC STATUS: RED GREEN GREY

HYDRAULIC CALIBRATION (Only Perform for Passage Status of GREY when Baffles are NOT Present)

Tailwater Cross Section Looking upstream to Point 9: Stationing is from Left bank to Right bank

Station	BS (+)	HI	FS(+)	Elevation	Notes

Calculate Discharge Mid-Culvert (Finish & Proceed to Sketch) Other (Finish & Proceed to Culvert Conveyance)

Station	Width (ft)	Depth (ft)	A (ft ²)	V (ft/s)

Station	Width (ft)	Depth (ft)	A (ft ²)	V (ft/s)

Figure C-23: Page 3 of Combined Fish Passage Assessment of Diamond Fork #1 & #2 Culverts

CULVERT DATABASE ID#: _____ (Assigned by UDOT ETS)

LONGITUDINAL **FISH PASSAGE ASSESSMENT FIELD DATA SHEET**

Surveyor Names: Aaron Beavers, Ashton Beavers Field Date: 3/22/08

SITE

Barrels: 2 Barrel #: 1-2 of 2 (UDOT culvert)
UDOT Region: _____ Route #: 6 Milepost #: _____ Stream Name: Diamond Fork
GPS: (Lat): 40.028167 (Long): 111.501325 Coordinate System: NSG 84 Units: Decimal Degrees

PHOTOS: Provide Photo #'s, Locations, and Shot Orientation in Sketch

- (1) Embankment Looking Upstream (2) Embankment Looking Downstream
 (3) Looking at Outlet to include Outlet Control (4) Internal Culvert Structures (5) Slope Break in Culvert
 (6) Looking at Inlet from 25 ft (7) Instream Structures (8) Bank Stabilization Structures (9) Local Erosion
 (10) Local Failures (11) Channel Incision (12) Channel Aggradation (13) Other: _____

CULVERT DATA:

Physical: Length: 590 (ft) Rise: 10 (ft) Span: 12 (ft) Diameter: _____ (ft)
Scour width: 70 (ft) Scour length: 60 (ft)
Corrugation (height): _____ (in.) (width): _____ (in.)
Material: Steel Aluminum PVC HDPE Concrete Other: _____
Shape: Box Circular Pipe Pipe-arch (Squash Pipe) Horizontal Ellipse Arch Arch Box
Roughness: Smooth Corrugated Annular Corrugated Spiral Plated Paved Baffles Slope Breaks
Inlet: Projected Mitered Headwall Wingwall (10-30 Deg) Wingwall (30-70 Deg) Apron Embedded
Inlet Edge Conditions: Grooved Edge Square Edge Beveled Edge
Outlet: At stream grade Perched Cascade Freefall Apron RipRap Embedded
Hydraulic Jump: Absent Present
Hydraulic Jump Location: Inlet Outlet Upper 3rd Middle 3rd Lower 3rd

SUBSTRATE DATA: Provide Substrate Characteristics and Geometry in Sketch

Condition: Absent Continuous Discontinuous Patchy
Inlet: Absent Present Outlet: Absent Present
Observed Size: Boulders Cobble Gravel Sand Fines
Notes: Several sections of both fish baffles are completely obstructed with
sediments of varying size

Assessment duration: 37 min

Figure C-24: Page 4 of Combined Fish Passage Assessment of Diamond Fork #1 & #2 Culverts

LONGITUDNAL SURVEY DATA

Benchmark: Inlet Invert Outlet Invert Rod Height: 5 (ft)

Channel

UDBT
Culvert

Station	BS (+)	HI	FS(+)	Horizontal	Elev	Notes	Nomenclature
1	2.343						BM = Benchmark
2	2.713						TP = Turning Point
3	2.855						CC = Culvert Ceiling
4a	90.61					4a approx ~ 46	SB = Stream Bed
4b	90.61						I = Invert
9	-1.585						RS = Road Surface
8						Too deep	S = Slope Break
7						Too deep	A = Apron
6						Too deep / fast	LB = Left Bank
5A	-1.51					S = 5A	RB = Right Bank
Additional							
4b	28.05						
4a	29.13						
1	-1.51						
2						Too deep	
3	-1.585						
5A	-9.755					S = 5A	
6	-11.811						
7						Too deep / fast	
8						Too deep / fast	
9	-11.025						
10	-12.255						

Rt
Culvert

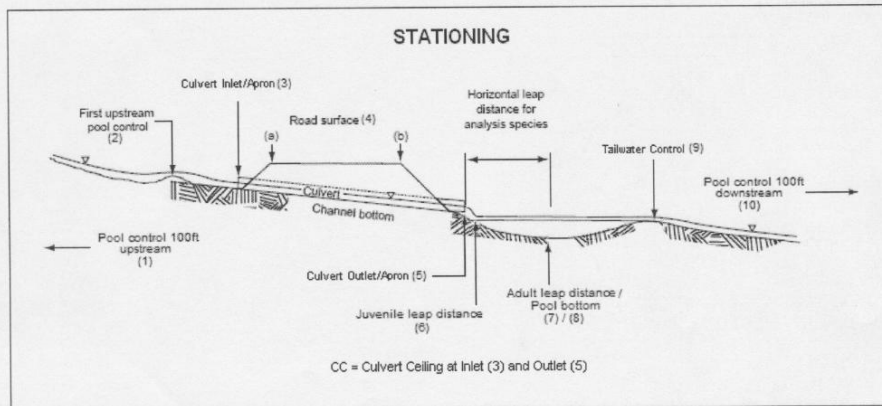

Figure 1. Longitudinal Profile Stations (Modified USFS Photo Clarkin et al)

Horizontal Distances

d(1)_{1→2}: 123 (ft) d(2)_{2→3}: 30 (ft) d(3)_{3→5}: 590 (ft) d(4)_{9→10}: NA (ft)

Figure C-25: Page 5 of Combined Fish Passage Assessment of Diamond Fork #1 & #2 Culverts

FIELD CALCULATIONSCulvert Slopes: Invert Slope $_{3 \Rightarrow 5}$: 0.69 (%) Ceiling Slope $_{3Top \Rightarrow 5Top}$: _____ (%)

Inlet/Outlet Depth/Drop: Residual Inlet Depth: _____ (ft) Outlet Drop: _____ (ft)

Culvert Length/Slope Product: Culvert Length (ft) X Culvert Slope (%): _____ (ft)

Scour Hole to Culvert Width: _____ (ft/ft)

CULVERT FISH PASSAGE STATUSADULT SALMONID STATUS: RED GREEN GREYJUVENILE SALMONID STATUS: RED GREEN GREYCYPRINIDAE STATUS: RED GREEN GREYSMALL BENTHIC STATUS: RED GREEN GREY**HYDRAULIC CALIBRATION** (Only Perform for Passage Status of GREY when Baffles are **NOT** Present)

Tailwater Cross Section Looking upstream to Point 9: Stationing is from Left bank to Right bank

Station	BS (+)	HI	FS(+)	Elevation	Notes

Calculate Discharge Mid-Culvert (Finish & Proceed to Sketch) Other (Finish & Proceed to Culvert Conveyance)

Station	Width (ft)	Depth (ft)	A (ft ²)	V (ft/s)

Station	Width (ft)	Depth (ft)	A (ft ²)	V (ft/s)

Figure C-26: Page 6 of Combined Fish Passage Assessment of Diamond Fork #1 & #2 Culverts

CULVERT CONVEYANCE

Standard Culvert Conveyance CSA

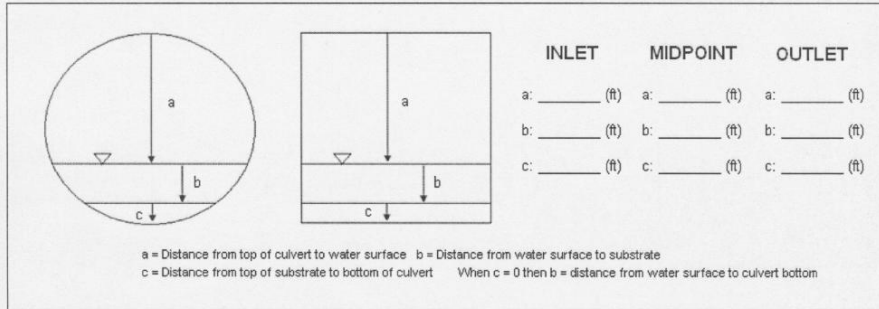

The depth at (c) can be solved for by subtracting (a) and (b) from a known culvert diameter or rise. If the culvert is sufficiently embedded at the inlet and outlet, and the depth at (c) cannot be easily obtained; notate (c) as "NA".

Notes: _____

BAFFLE SKETCH:

- Top View Orientation
- Horizontal Side View Orientation
- Horizontal Cross Sectional View Orientation
- Baffle Angles
- Distance Between Baffles (Spacing)
- Baffle Pattern
- Baffle Height

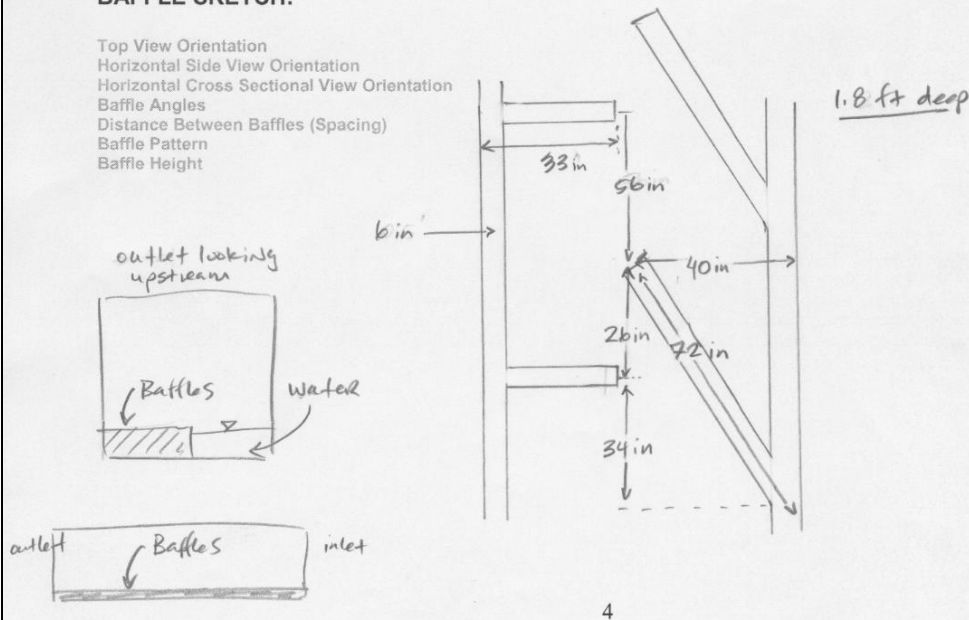

Figure C-27: Page 7 of Combined Fish Passage Assessment of Diamond Fork #1 & #2 Culverts

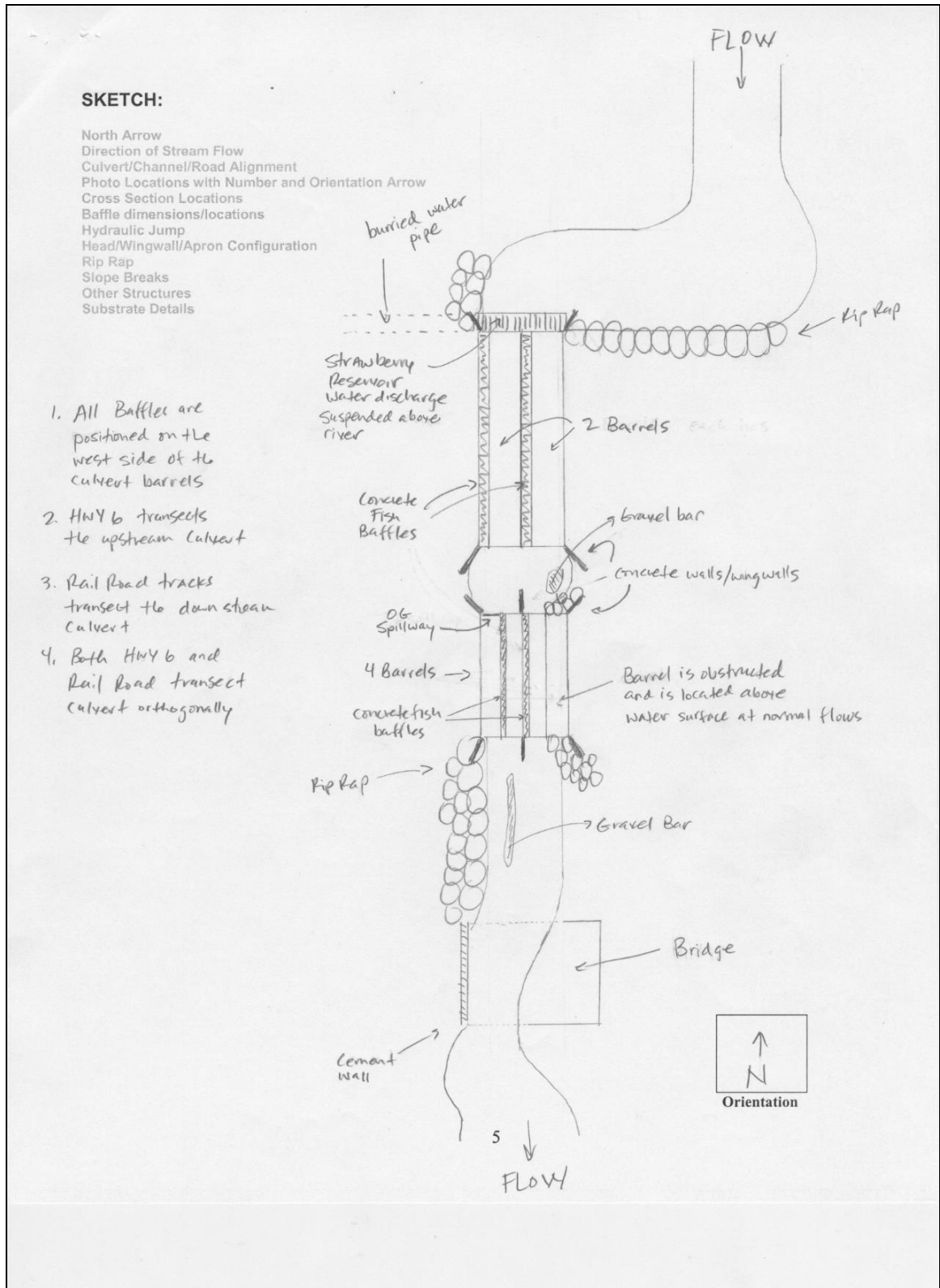

Figure C-28: Page 8 of Combined Fish Passage Assessment of Diamond Fork #1 & #2 Culverts

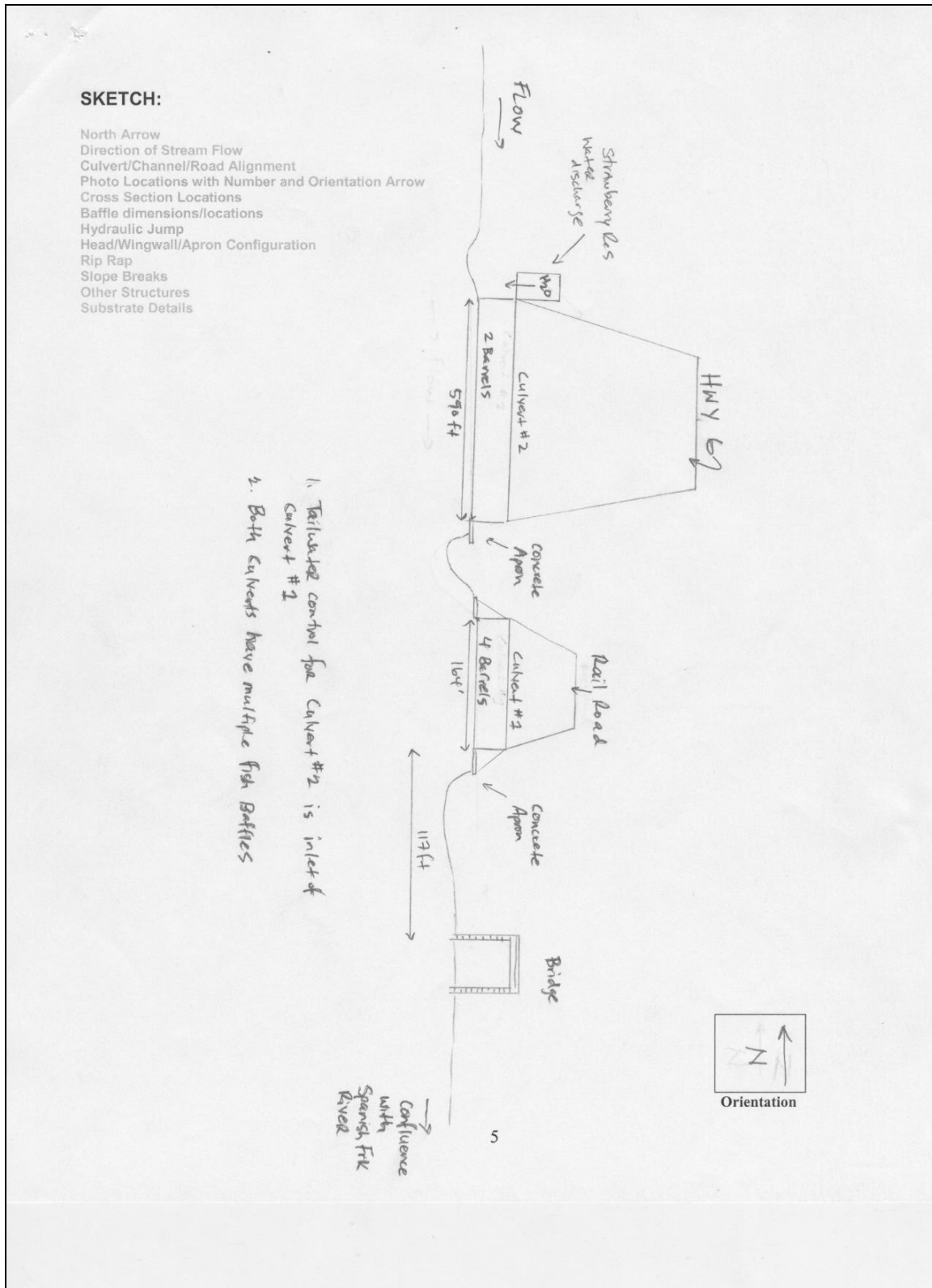

Figure C-29: Page 9 of Combined Fish Passage Assessment of Diamond Fork #1 & #2 Culverts

Appendix D Assessment Training Manual

As part of the project a culvert assessment training manual was created. The UDOT Culvert Assessment Training Manual (CATM) contains information to train UDOT employees and volunteers on both the hydraulic (section 3) and fish passage (section 4) assessments. The CATM has been formatted to the same format as this report. It contains its own table of contents, list of figures and tables and related appendices.

TABLE OF CONTENTS

LIST OF FIGURES	167
1 Introduction.....	171
2 Safety.....	173
3 Assessment Preparation	175
3.1 Hydraulic Evaluation Teams	175
3.2 Fish Passage Assessment Teams	175
3.3 Site Preparation.....	176
4 Hydraulic Evaluation.....	177
4.1 Equipment List.....	177
4.2 Data.....	178
4.3 Outlet Flow	181
4.4 Backwatered Culvert.....	183
4.5 Elevated Outlet	187
4.6 Hydraulic Filter.....	189
5 Fish Passage Assessment	191
5.1 Equipment List.....	191
5.2 Data.....	192
5.3 Site Information	193
5.4 Site Photos	194
5.4.1 Embankment Looking Upstream	195

5.4.2	Embankment Looking Downstream	197
5.4.3	Looking at the Outlet	198
5.4.4	Internal Culvert Structures	202
5.4.5	Slope Breaks in Culvert	206
5.4.6	Looking at Inlet.....	206
5.4.7	Instream Structures	207
5.4.8	Bank Stabilization Structures.....	209
5.4.9	Local Erosion	211
5.4.10	Local Failures.....	213
5.4.11	Other	215
5.5	Culvert Data.....	215
5.5.1	Physical Data	216
5.5.2	Corrugations.....	216
5.5.3	Material.....	217
5.5.4	Roughness	218
5.5.5	Shape.....	217
5.5.6	Inlet	219
5.5.7	Outlet.....	221
5.6	Hydraulic Jump and Location.....	225
5.7	Substrate Data.....	228
5.8	Longitudinal Survey	230
5.8.1	Benchmark	234
5.8.2	Accuracy	235
5.8.3	Set Up.....	235
5.8.4	Embedded Culverts.....	235

5.9	Stream Slope Distances	236
5.10	Field Calculations	237
5.11	Fish Passage Status	239
5.12	Further Analysis of GREY Status Culverts	241
5.13	Hydraulic Calibration	242
5.13.1	Tailwater Cross Section Survey	243
5.13.2	Calculating Discharge	246
5.14	Site Sketch	247
5.14.1	Culvert/Channel/Road Alignment	248
5.14.2	Photo Locations	248
5.14.3	Baffles	248
5.14.4	Head/Wingwall/Apron Configuration.....	248
5.14.5	Riprap.....	249
5.14.6	Locations.....	249
References		251
Appendix A	Fish Passage Assessment Field Data Sheets.....	253
Appendix B	Fish Screens	259
Appendix C	Example Field Data Sheet	263

LIST OF FIGURES

Figure 4-1: Hydraulic Evaluation Photo Taken at the Inlet.....	179
Figure 4-2: Hydraulic Evaluation Photo Taken at the Outlet.....	179
Figure 4-3: Hydraulic Evaluation Photo Taken at the Inlet.....	180
Figure 4-4: Hydraulic Evaluation Photo Taken at the Outlet.....	180
Figure 4-5: Correct Posture and Orientation for Determining Outlet Flow With a Wading Staff.....	181
Figure 4-6: Sub-Critical Flow Wave Action on the Upstream Side of a Wading Staff.....	182
Figure 4-7: Critical Flow Wave Action on Wading Staff.....	183
Figure 4-8: Inlet of Backwatered Culvert #1.....	184
Figure 4-9: Outlet of Backwatered Culvert #1.....	184
Figure 4-10: Inlet of Backwatered Culvert #2.....	185
Figure 4-11: Outlet of Backwatered Culvert #2.....	185
Figure 4-12: Inlet of Backwatered Culvert #3.....	186
Figure 4-13: Outlet of Backwatered Culvert #3.....	186
Figure 4-14: Elevated Outlet.....	187
Figure 4-15: Elevated Outlet.....	188
Figure 4-16: Elevated Outlet.....	188
Figure 4-17: Elevated Outlet.....	189
Figure 4-18: Hydraulic Filter.....	190
Figure 5-1: Embankment Looking Upstream Photo.....	196
Figure 5-2: Additional Embankment Looking Upstream Photo Showing Floodplain.....	196

Figure 5-3: Embankment Looking Downstream Photo	197
Figure 5-4: Additional Embankment Looking Downstream Photo Showing Floodplain	198
Figure 5-5: Outlet and Tailwater Control Photo	199
Figure 5-6: Photo of Discharge at Outlet Invert	199
Figure 5-7: Beaver Dam Tailwater Control Relative to the Culvert Outlet.....	200
Figure 5-8: Backwater Conditions at Outlet Caused From Debris Dam	201
Figure 5-9: Debris Dam Causing Backwater Conditions	201
Figure 5-10: Wildlife Trail in Culvert	202
Figure 5-11: Photo at Outlet of Fish Baffles.....	203
Figure 5-12: Photo of Fish Baffles Mid-Culvert.....	203
Figure 5-13: Photo of Fish Baffles at Inlet (Looking Upstream).....	204
Figure 5-14: Fish Baffles Filled in With Sediment.....	204
Figure 5-15: Spillway at Inlet	205
Figure 5-16: Detailed View of Spillway at Inlet.....	205
Figure 5-17: Debris Pile at Culvert Outlet.....	206
Figure 5-18: Photo of Inlet From 25 Feet	207
Figure 5-19: Two Small Diversions Within 100 ft. Downstream of a Culvert Outlet.....	208
Figure 5-20: Large Boulders Downstream of a Culvert Outlet	208
Figure 5-21: Riprap at Toe of Outlet Wingwall.....	209
Figure 5-22: Riprap and Sheet Pile Near Inlet.....	210
Figure 5-23: Gabion Wall	210
Figure 5-24: Gabion Wall	211
Figure 5-25: Erosion Behind Wingwall	212
Figure 5-26: Stream Bank Erosion	212
Figure 5-27: Culvert Separating from Headwall	213

Figure 5-28: Possible Road-Side Erosion Associated with Figure 5-27.....	214
Figure 5-29: Stream Bank Erosion and Failure of a Culvert Headwall.....	214
Figure 5-30: Basic Culvert Orientation.....	215
Figure 5-31: Corrugation Dimensions	216
Figure 5-32: Culvert Shapes (Modified USFS 2006)	218
Figure 5-33: Several Types of Corrugation Patterns (Modified USFS 2008)	217
Figure 5-34: Plated Culvert.....	219
Figure 5-35: Several Inlet Types and Edge Configurations (Modified FHWA 2007)	220
Figure 5-36: Culvert Headwall, Wingwalls and Apron	221
Figure 5-37: Probable Outlet Configurations at Stream Grade	222
Figure 5-38: Free Fall into Pool or Perched Culvert.....	223
Figure 5-39: Cascade Over Riprap	223
Figure 5-40: Free Fall Onto Riprap	224
Figure 5-41: Embedded Culvert Outlet.....	225
Figure 5-42: Hydraulic Jump Just Upstream of Inlet.....	226
Figure 5-43: Hydraulic Jump Just Inside Culvert Inlet.....	226
Figure 5-44: Hydraulic Jump Just Downstream of Outlet.....	227
Figure 5-45: Hydraulic Jump at End of Outlet Apron	227
Figure 5-46: Measurement of the Intermediate Axis of Larger Substrate (Harrelson 1994).....	229
Figure 5-47: Basic Riffle/Pool Stream Morphology.....	231
Figure 5-48: Pool Control	231
Figure 5-49: Stationing for Longitudinal Profile Survey (Modified Clarkin et al. 2003)	232
Figure 5-50: Adult Salmonid Fish Screen (Modified Coffman 2005).....	240
Figure 5-51: Stationing for Tailwater Cross Section Survey.....	244
Figure A-1: Page 1 Fish Passage Assessment.....	254

Figure A-2: Page 2 Fish Passage Assessment.....	255
Figure A-3: Page 3 Fish Passage Assessment.....	256
Figure A-4: Page 4 Fish Passage Assessment.....	257
Figure A-5: Page 5 Fish Passage Assessment.....	258
Figure B-1: Adult Salmonid Fish Screen.....	260
Figure B-2: Young of Year Salmonid and Cyprinidae Fish Screen	261
Figure B-3: Benthic Fish Screen.....	262
Figure C-1: Fish Passage Assessment Example Page 1.....	264
Figure C-2: Fish Passage Assessment Example Page 2.....	265
Figure C-3: Fish Passage Assessment Example Page 3.....	266
Figure C-4: Fish Passage Assessment Example Page 4.....	267
Figure C-5: Fish Passage Assessment Example Page 5.....	268

1 Introduction

This document is designed to train and instruct UDOT employees and volunteers on the correct method of performing hydraulic evaluation and fish passage assessment. Personnel, safety, and equipment use or other guidelines contained in this document do not supersede established UDOT guidelines or standard operating procedure. When conflicts arise the procedures contained in this document should be modified or amended to reflect current UDOT regulations and guidelines. Training should be performed by individuals familiar with current UDOT safety requirements. Ideally training staff should also possess familiarity with surveying, stream morphology and culvert hydraulics and design.

2 Safety

Considerations:

- Vehicle parking spot (shoulder) has adequate room to safely load/unload people/equipment
- Vehicle parking spot has adequate sight distance in both directions
- Assess level of traffic in general site area and familiarize yourself to sight distances and speed of traffic
- Post cones, working signs or flaggers where/when needed
- Ensure safe entry and exit paths to culvert assessment site
- Thick abrasive brush
- Steep slopes
- Loose cobble/gravel
- Traverse easiest slopes to culvert

Remember:

- Running water and traffic sound similar
- Weather conditions effect traffic hazards
- Slippery and uneven streambed/culvert pose hazards
- Rusted culvert bottoms pose hazards

- High/fast stream flows can be dangerous
- Use caution when removing brush or other obstructions
- Assess culvert and general site for wasps/bees/hornet nests
- Assess site for other wildlife
- Drink enough water & stay warm

3 Assessment Preparation

3.1 Hydraulic Evaluation Teams

Evaluation teams should be properly trained on the evaluation procedure. Training should be expected to last up to eight hours (including two hours travel time to field culvert site) while providing hands-on training in the field. This training should also include instruction on UDOT safety protocol. Evaluation teams should possess no less than two people. Experienced teams can expect to spend approximately five minutes or less at each site depending on the physical conditions of the site.

3.2 Fish Passage Assessment Teams

Assessment teams should be properly trained on the assessment procedure. Training should be expected to last two to three days and provide on hands training in the field as well as classroom instruction. This training should also include instruction on UDOT safety protocol. Assessment teams should possess at least two people. Experienced teams can expect to spend twenty to forty minutes at each assessment site depending on the level of assessment necessary and the physical conditions of the site.

3.3 Site Preparation

Heavy brush may have to be removed to gain access to the culvert site or create a clear path for photographs or surveying. Do not move or attempt to cut/fell/move large or heavy obstacles. If brush needs to be removed utilize the camp saw and clippers to remove the brush. Always cut paths along the gentlest slope to gain access to the stream. Always use caution when removing brush. The brush presents poking/stabbing hazards as well as cutting hazards when using sharp tools. Remember to be watchful for bee/hornet/wasp nests. Ensure you are wearing the following while removing brush:

- Hard hat
- Safety Glasses
- Leather Gloves

Follow UDOT guidelines for posting signs or flaggers relative to the work you are performing and its proximity to the roadway.

4 Hydraulic Evaluation

4.1 Equipment List

- Field Copy: Instruction for Fish Passage Assessment of UDOT Culverts
- Standard UDOT required safety gear
- Standard UDOT road/work crew posting equipment
- Hard hat
- Leather gloves
- Safety glasses
- Safety vest (hi-viz)
- Waders
- Wading belt
- Felt soled boots
- Wading staff
- Shoulder bag
- Flashlight/headlamp
- Digital camera & extra batteries
- GPS unit & extra batteries
- Hand held radios w/ clip/harness

- First aid kit
- Folding Camp Saw & Brush Clippers
- Regional map
- White eraser board
- Black dry markers

4.2 Data

Data physically obtained at culvert sites:

- GPS coordinates of culvert inlet
- Outlet flow condition
- Outlet elevation orientation
- Culvert backwater condition

Photographs are taken with a crew member holding an erasable white board in the photo with the following data legibly inscribed with a dark erasable marker (figures 4-1 through 4-3):

- Month/Day/Year
- “Inlet” or “Outlet” identifying correct culvert opening in photo
- GPS coordinates of inlet (North and West in decimal degrees)
- “Backwatered” or “Not-Backwatered” identifying the culvert backwater condition
- “Critical” or “Sub-Critical” identifying critical or sub-critical flow at the outlet
- “Elevated” or “Not-Elevated” identifying outlet elevation orientation



Figure 4-1: Hydraulic Evaluation Photo Taken at the Inlet



Figure 4-2: Hydraulic Evaluation Photo Taken at the Outlet



Figure 4-3: Hydraulic Evaluation Photo Taken at the Inlet



Figure 4-4: Hydraulic Evaluation Photo Taken at the Outlet

4.3 Outlet Flow

The critical and sub-critical flow of water at the culvert outlet can be determined by using a wading staff. The staff must be held in the following manner (figure 4-5):

- At an arms length upstream of the holder
- Staff is placed in the middle of the outlet invert
- Holder stands downstream of the staff
- Holder positions her/himself to one side of the staff, not directly downstream



Figure 4-5: Correct Posture/Orientation for Determining Outlet Flow With a Wading Staff

At this point wave action at the upstream side of the staff can be used to evaluate critical or sub-critical flow conditions. If waves can be seen propagating upstream of the staff this indicates sub-critical flow (figure 4-6). An absence of these upstream moving waves indicates critical flow (figure 4-7).



Figure 4-6: Sub-Critical Flow Wave Action on the Upstream Side of a Wading Staff



Figure 4-7: Critical Flow Wave Action on Wading Staff

4.4 Backwatered Culvert

A backwatered culvert can be visually determined by a generally smooth water surface near the inlet and outlet with no noticeable change in water surface slope between the inlet and outlet. The following photographs are indicative of what is defined in this document as a backwatered culvert (figures 4-8 through 4-13).



Figure 4-8: Inlet of Backwatered Culvert #1



Figure 4-9: Outlet of Backwatered Culvert #1



Figure 4-10: Inlet of Backwatered Culvert #2



Figure 4-11: Outlet of Backwatered Culvert #2



Figure 4-12: Inlet of Backwatered Culvert #3



Figure 4-13: Outlet of Backwatered Culvert #3

4.5 Elevated Outlet

An elevated outlet can be visually determined by noticeable drop in water surface elevation at the outlet. The following photographs are indicative of what is defined in this document as an elevated outlet (figures 4-14 through 4-17).



Figure 4-14: Elevated Outlet



Figure 4-15: Elevated Outlet



Figure 4-16: Elevated Outlet



Figure 4-17: Elevated Outlet

4.6 Hydraulic Filter

The hydraulic evaluation is used in conjunction with the hydraulic filter. The hydraulic filter is meant to be a very rough filter, not a declaration of the culverts absolute fish passage status. It's used to regionally prioritize culverts by rating them on a scale of R1 to R3, with a value of R1 being the highest priority (R denotes regional priority). The hydraulic filter (figure 4-18) aids in prioritizing culverts for a future fish passage assessment.

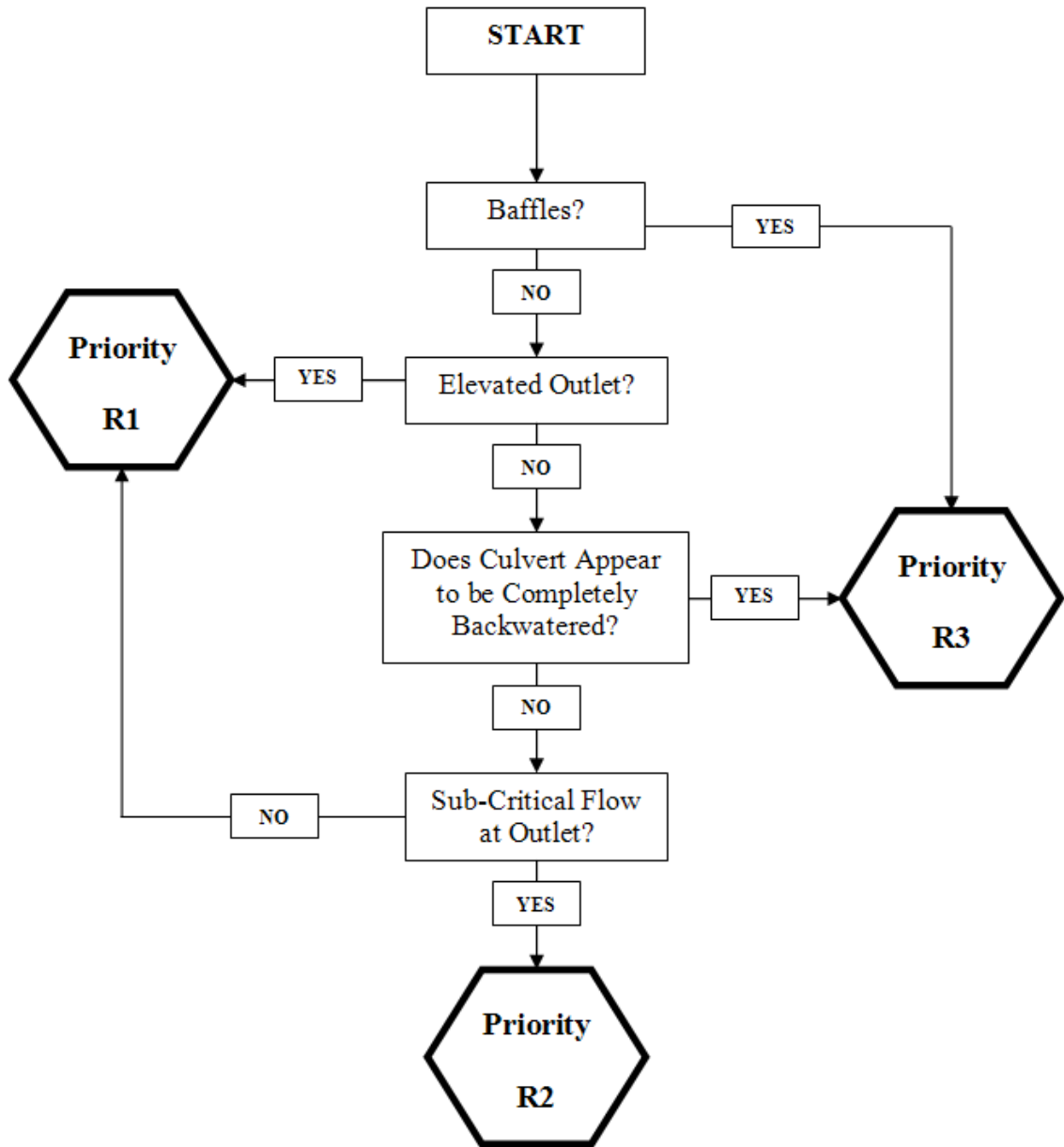

Figure 4-18: Hydraulic Filter

5 Fish Passage Assessment

5.1 Equipment List

- Field Copy: Instruction for Fish Passage Assessments of UDOT Culverts
- Fish Passage Assessment Field data sheets
- Standard UDOT required safety gear
- Standard UDOT road/work crew posting equipment
- Standard UDOT survey equipment
- Hard hat
- Leather gloves
- Safety glasses
- Safety vest (hi-viz)
- Waders
- Wading belt
- Felt soled boots
- Wading staff
- Shoulder bag
- Ruler
- Flashlight/headlamp

- Digital camera & extra batteries
- 300 ft fiberglass tape measure
- 25 ft hand tape
- Landscape markers/flags
- GPS unit & extra batteries
- Hand held radios w/ clip/harness
- First aid kit
- Folding Camp Saw & Brush Clippers
- Clip boards
- Pencils
- Regional map
- Velocity meter & associated discharge calculation equipment
- Calculator & extra batteries
- White eraser board
- Black dry marker

The reader is encouraged to follow along with a copy of the fish passage assessment field data sheet located in Appendix A.

5.2 Data

At the end of the assessment collected data will be utilized to determine a fish passage status of the culvert. The field data sheet is broken up into nine main tasks:

- Site Information
- Photos
- Culvert data
- Substrate data
- Longitudinal Survey data
- Field calculations
- Culvert Fish Passage Status & Fish Screens
- Hydraulic calibration
- Site Sketch

Throughout performing the assessment annotate any and all explanations and/or comments which help describe conditions as they really exist. Additionally, notes should include comments to you to help keep the data in order.

5.3 Site Information

This section contains regional and local topographical data. UDOT region, route number, milepost number, and stream name can be obtained from regional maps. If the milepost number or stream name cannot be determined it's reported as "unknown".

GPS coordinates should be taken at the upstream side of the culvert at the culvert inlet; ideally directly above the inlet. Ensure the GPS coordinates correlate with the perceived map location of the assessment site. Record the coordinate system the GPS coordinates were obtained in and the respective units they are reported in.

Take time to visually inspect the entire site. Identify and assess all potential hazards. Utilize this time to familiarize yourself with your surroundings and make an initial sketch of the road-stream crossing. This initial sketch should include:

- North arrow
- Culvert to include headwalls and wingwalls
- Stream
- Road
- Road/Stream Orientation
- Flow direction

Refer section 5.11 of this document for detailed site sketch information.

5.4 Site Photos

This section contains general photo descriptions of key data used to evaluate the physical conditions of the culvert itself, additional local structures, and local stream morphology.

Photos have been divided into eleven categories. Each has been assigned a numerical value of one through eleven. The location of the photo and its orientation relative to the culvert should be indicated on the sketch portion of the field data sheet.

Photos categories for each site include the following:

- Embankment looking upstream
- Embankment looking downstream
- Looking at Outlet

- Internal culvert structures
- Slope Break in culvert
- Looking at the inlet
- Instream structures
- Bank stabilization structures
- Local erosion
- Local failures
- Other

5.4.1 Embankment Looking Upstream

This photo should be taken from above the culvert inlet looking upstream. The photo should capture the culvert inlet and the immediate area upstream of the culvert. Usually, this first photo will also contain the general floodplain topography of the channel. If not, take additional photos which include the general topography of the floodplain (figures 5-1 & 5-2).



Figure 5-1: Embankment Looking Upstream Photo



Figure 5-2: Additional Embankment Looking Upstream Photo Showing Floodplain

5.4.2 Embankment Looking Downstream

This photo should be taken from above the culvert outlet looking downstream. The photo should capture the immediate area of the culvert outlet and scour hole or the first pool immediately downstream of the culvert outlet. Usually, this photo also contains the first downstream riffle and the floodplain topography. If not, take additional photos which include the first downstream riffle and general topography of the area (figures 5-3 & 5-4).



Figure 5-3: Embankment Looking Downstream Photo



Figure 5-4: Additional Embankment Looking Downstream Photo Showing Floodplain

5.4.3 Looking at the Outlet

At least two photos should be taken. The first photo should be taken from a position downstream of the tailwater control for first downstream riffle and should include at least the tailwater control and culvert outlet to include head and/or wingwalls. The second photo should include a close up of discharge at the outlet invert (figures 5-5 & 5-6).



Figure 5-5: Outlet and Tailwater Control Photo



Figure 5-6: Photo of Discharge at Outlet Invert

Often the tailwater control of the culvert is not a part of the natural channel morphology. Tailwater controls can be downstream beaver dams or debris/log jams or other instream obstructions. Take pictures of these cases relative to the culvert if possible. Mark the location of the tailwater control in the sketch (figures 5-7 through 5-9).



Figure 5-7: Beaver Dam Tailwater Control Relative to the Culvert Outlet



Figure 5-8: Backwater Conditions at Outlet Caused From Debris Dam



Figure 5-9: Debris Dam Causing Backwater Conditions

5.4.4 Internal Culvert Structures

Internal structures can be natural or man made structures (figures 5-10 through 5-17). Man made structures might include fish baffles or wildlife/pedestrian trails. Natural structures may include wedged logs, debris piles or other material clogged in the culvert. Culverts containing fish baffles should include close up photos of the baffles at the outlet, mid-culvert, and inlet. Remember to mark the location of internal structures or conditions in the sketch.



Figure 5-10: Wildlife Trail in Culvert



Figure 5-11: Photo at Outlet of Fish Baffles



Figure 5-12: Photo of Fish Baffles Mid-Culvert



Figure 5-13: Photo of Fish Baffles at Inlet (Looking Upstream)



Figure 5-14: Fish Baffles Filled in With Sediment



Figure 5-15: Spillway at Inlet



Figure 5-16: Detailed View of Spillway at Inlet



Figure 5-17: Debris Pile at Culvert Outlet

5.4.5 Slope Breaks in Culvert

Slope breaks represent a noticeable change in the physical culvert slope between the inlet and culvert; the culvert will take on a noticeable “bent” shape somewhere inside the barrel. Take several photos and mark the location of the slope break in the sketch.

5.4.6 Looking at Inlet

This photo should be taken approximately twenty-five feet upstream of the culvert inlet. The photo should include the entire inlet including left and right stream banks and head/wingwalls (figure 5-18).



Figure 5-18: Photo of Inlet From 25 Feet

5.4.7 Instream Structures

Instream structures include natural or man made structures such as large trees, boulders, beaver dams, weirs, and diversions located in the general upstream and downstream area of the culvert (figures 5-19 & 5-20).



Figure 5-19: Two Small Diversions Within 100 ft. Downstream of a Culvert Outlet



Figure 5-20: Large Boulders Downstream of a Culvert Outlet

5.4.8 Bank Stabilization Structures

This category includes photos for bank stabilization structures not captured in previous photos (figures 5-21 through 5-24). Most bank stabilization structures will be contained in the photos of the culvert inlet and outlet.



Figure 5-21: Riprap at Toe of Outlet Wingwall



Figure 5-22: Riprap and Sheet Pile Near Inlet



Figure 5-23: Gabion Wall



Figure 5-24: Gabion Wall

5.4.9 Local Erosion

Any erosion local to the culvert not already captured in previous photos should be documented. Photos should be taken from an orientation which maximizes the photos ability to convey the magnitude of the erosion (figures 5-25 & 5-26).



Figure 5-25: Erosion Behind Wingwall



Figure 5-26: Stream Bank Erosion

5.4.10 Local Failures

Any failures local to the culvert should be captured with close up photos. Even those failures already captured in previous photos (figures 5-27 through 5-29). Take these pictures from a vantage point which best captures the problem the photo is describing.



Figure 5-27: Culvert Separating from Headwall



Figure 5-28: Possible Road-Side Erosion Associated with Figure 5-27



Figure 5-29: Stream Bank Erosion and Failure of a Culvert Headwall

5.4.11 Other

Any other photos deemed pertinent to document conditions vital to the performance of the mission of UDOT should be taken. This includes photos outside the scope of fish passage. These can include, but are not limited to, large scale failures occurring outside the general area of the culvert. These failures can include damaged culverts, bridges, roads, signs, medians, guardrails, and any other UDOT managed structure or equipment.

5.5 Culvert Data

The following illustration (figure 5-30) identifies some basic culvert orientation and information key to understanding and implementing this assessment procedure.

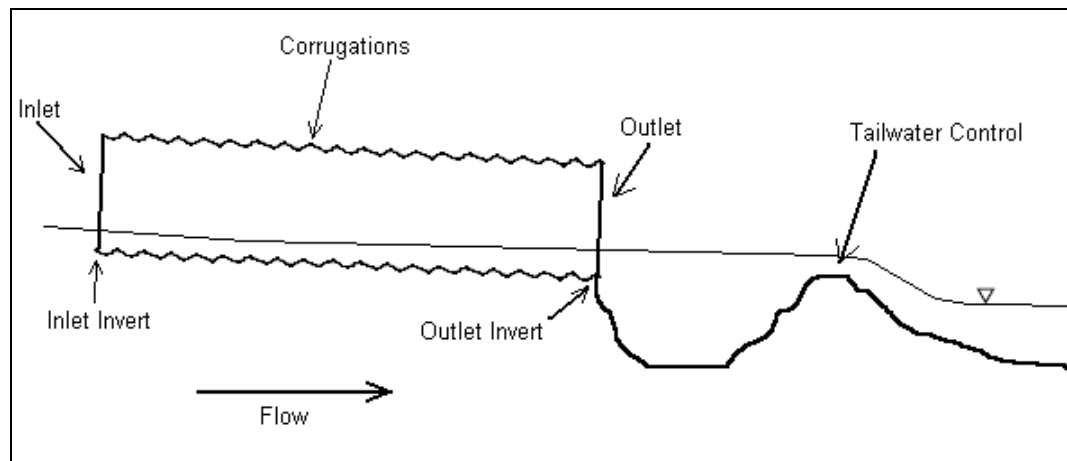

Figure 5-30: Basic Culvert Orientation

5.5.1 Physical Data

- Length: Linear distance of culvert from inlet to outlet
- Span: For non-circular culverts this represents the horizontal widest distance of either culvert opening
- Rise: For non-circular culverts rise represents the widest vertical distance of either culvert opening
- Diameter: Span for circular culverts
- Scour Width: Widest stream width between outlet and tailwater control
- Scour Length: Distance from outlet invert to tailwater control

5.5.2 Corrugations

See figure 5-31.

- Corrugation Height: Depth taken between successive corrugation peaks
- Corrugation Width: Peak to peak distance between successive corrugation peaks

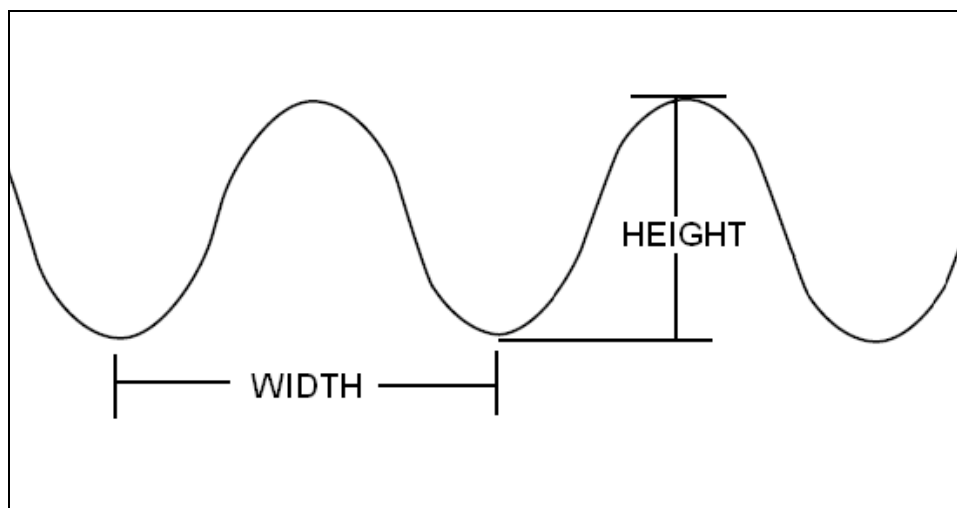

Figure 5-31: Corrugation Dimensions

5.5.3 Material

Culverts can be made out of several different types of materials, Steel and concrete culverts make up the bulk of the material used. Occasionally, culverts can be made out of other materials. Aluminum culverts can be identified by the lack of darker red/brown color associated with steel corrosion around the water line and/or water surface. Plastic like materials used to construct culverts are either constructed of Polyvinyl chloride (PVC) or High-density Polyethylene (HDPE); these can be smooth or corrugated barrels.

5.5.4 Roughness

Barrel roughness is smooth such as in some plastic or concrete culverts, metal pipes are usually corrugated. Corrugation orientation can be annular or spiral (figure 5-33).

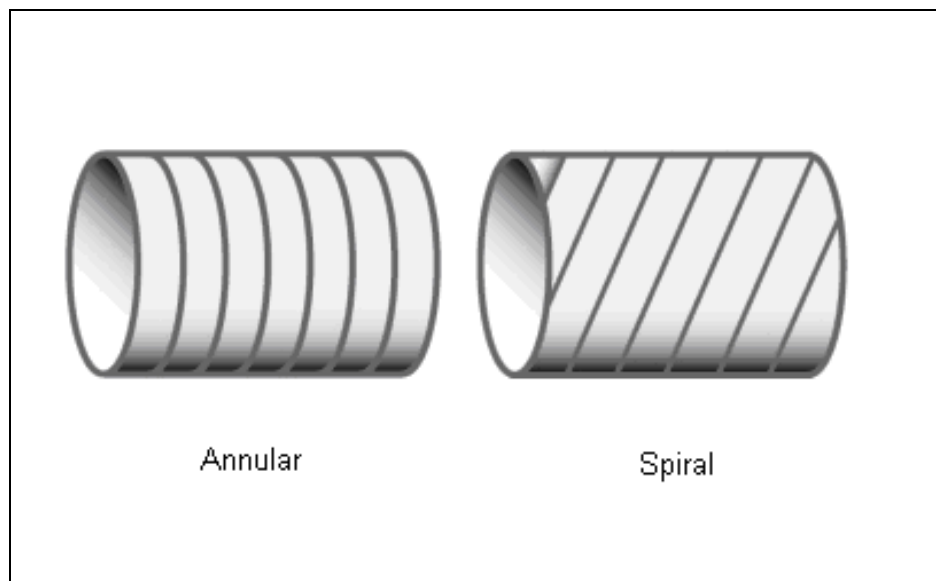

Figure 5-32: Several Types of Corrugation Patterns (Modified USFS 2008)

5.5.5 Shape

Culvert shapes included in the assessment procedure are contained in figure 5-32.

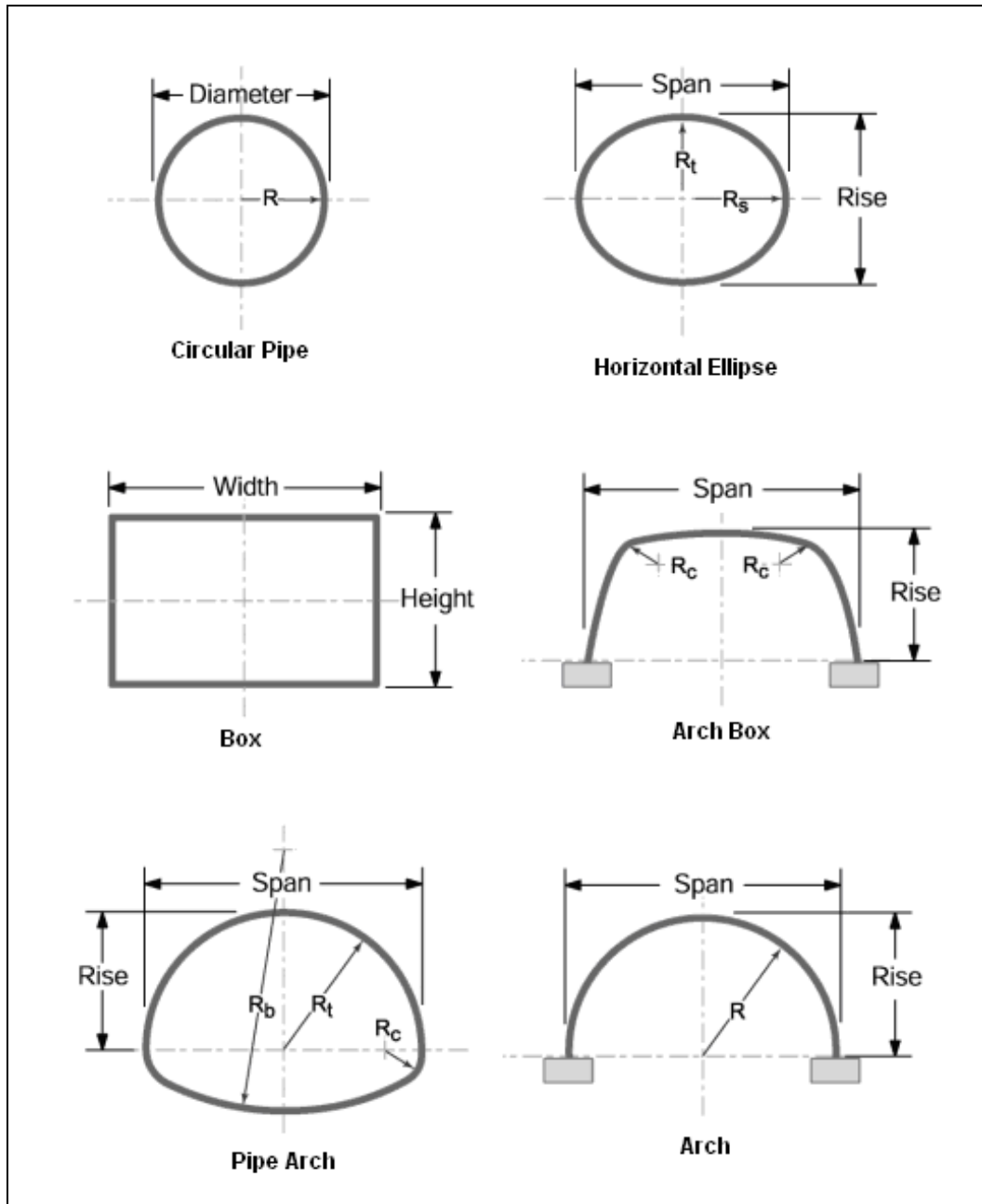

Figure 5-33: Culvert Shapes (Modified USFS 2006)

Often large culverts are plated. Plated culverts are identified by the sectional appearance of the culvert wall. These culverts are put together in pieces. Bolts can usually be seen along vertical and/or horizontal lines within the culvert indicating the several sections being bolted together (figure 5-34).



Figure 5-34: Plated Culvert

Culverts can also be paved. This condition is observed when the culvert bottom is lined with a concrete or asphalt type material.

5.5.6 Inlet

Culvert inlet configuration and inlet edge conditions contained in the assessment are illustrated in figures 5-35 & 5-36.

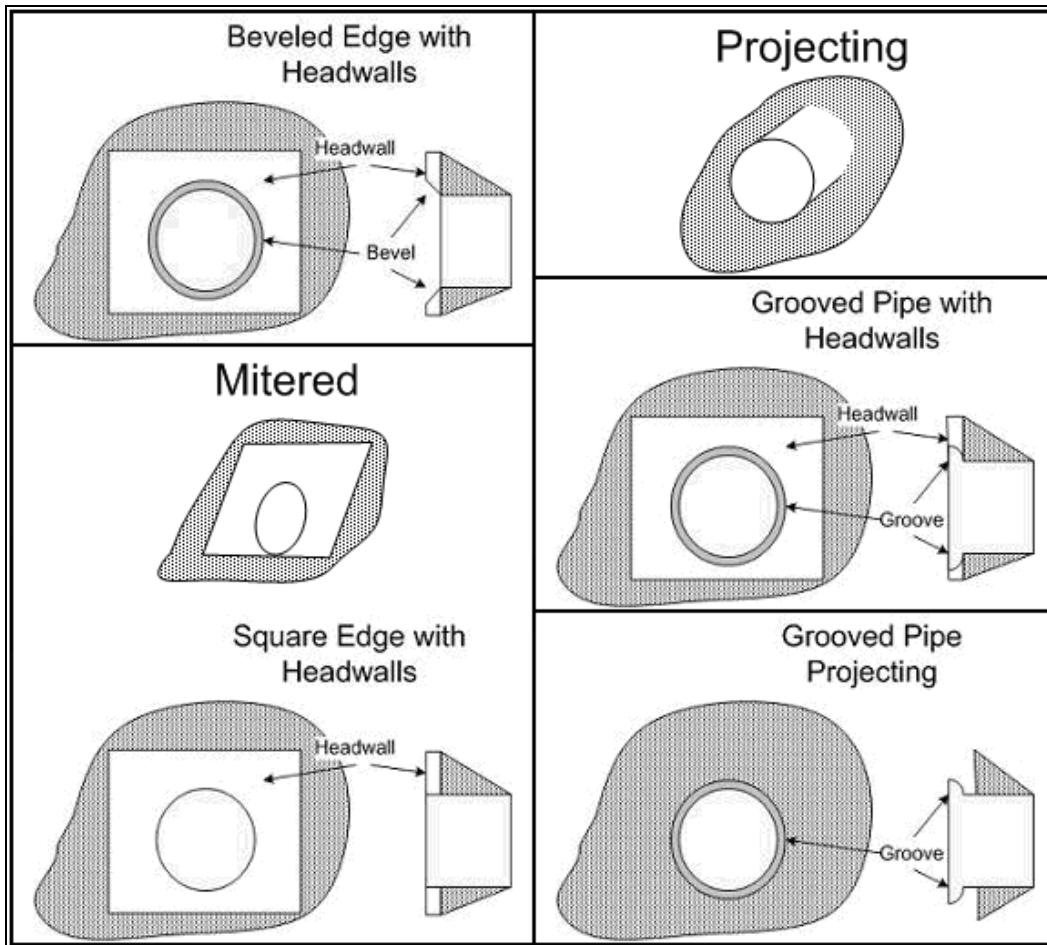

Figure 5-35: Several Inlet Types and Edge Configurations (Modified FHWA 2007)

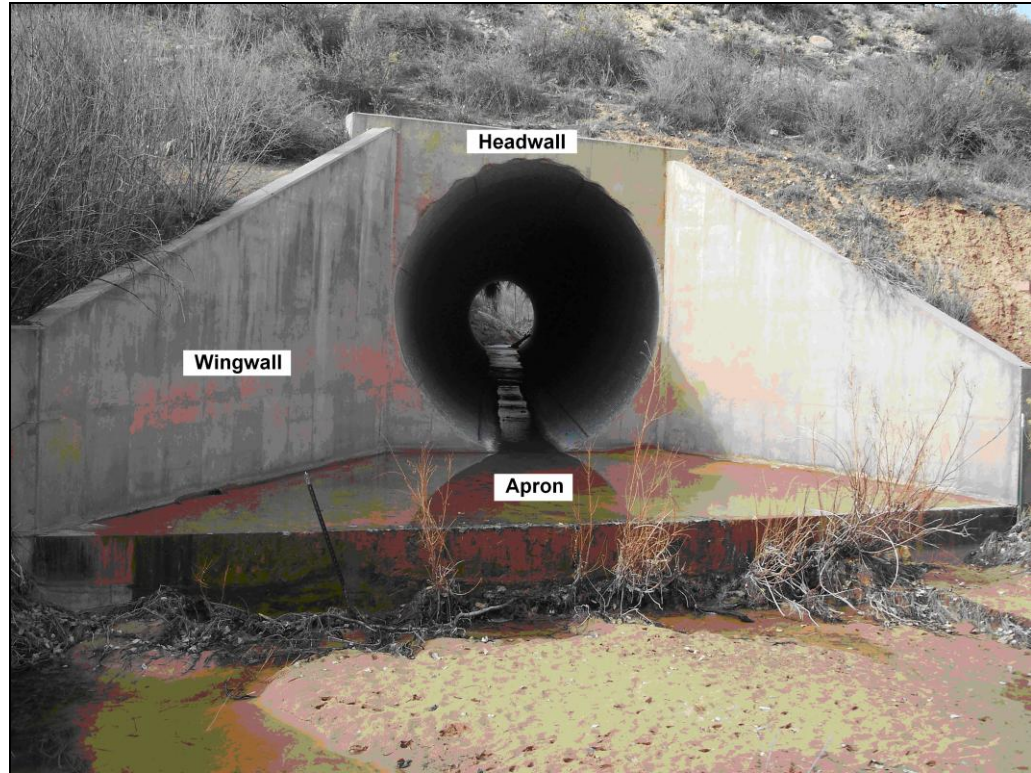

Figure 5-36: Culvert Headwall, Wingwalls and Apron

5.5.7 Outlet

This section contains examples of possible culvert outlet orientations contained in the field data sheet. A culvert outlet invert which is at stream grade (figure 5-37) may possess a thin layer of substrate, typically no more than a few inches. The depth of the substrate should be sufficient that you are able to easily brush aside the substrate to view the bare culvert invert with your boot or wading staff.

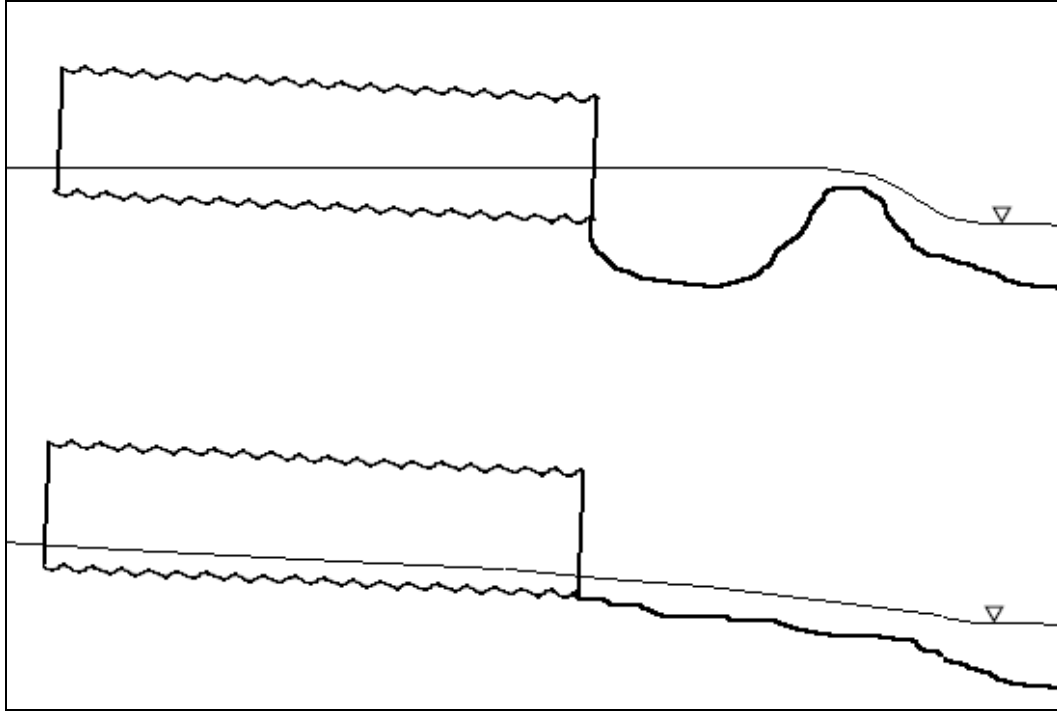

Figure 5-37: Probable Outlet Configurations at Stream Grade

A perched culvert possesses an outlet drop when the outlet invert elevation is greater than the elevation of the streambed at the tailwater control. The extreme of this condition can result in a free fall configuration where the flow “pours” out of the culvert and into the pool below (figure 5-38). A mildly perched condition can also occur without the pouring characteristic; this can look like normal flow exiting the culvert. Additionally, riprap can be placed at the outlet to prevent widespread scouring at the culvert outlet due to a perched condition (figures 5-39 & 5-40).

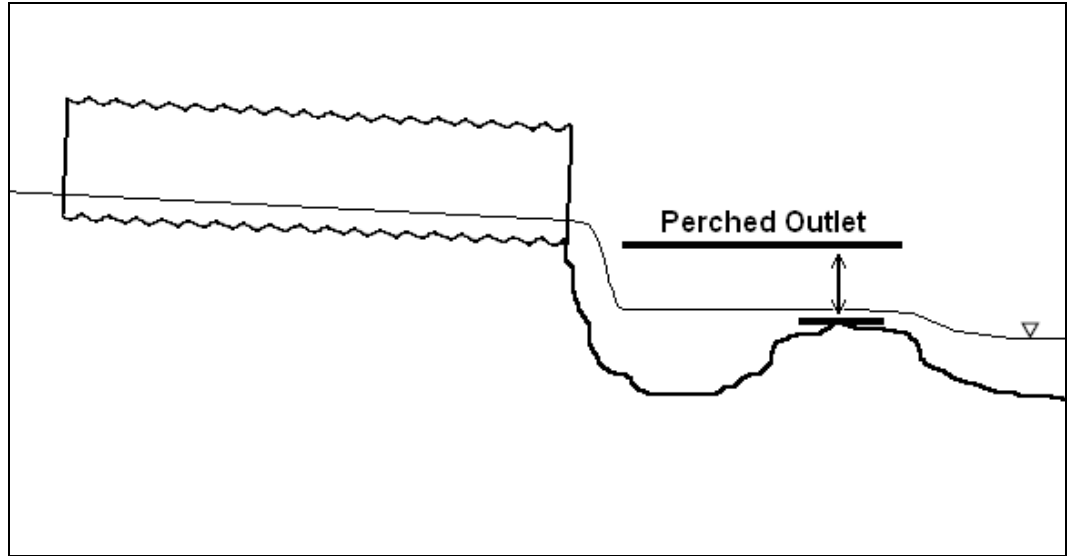

Figure 5-38: Free Fall into Pool or Perched Culvert

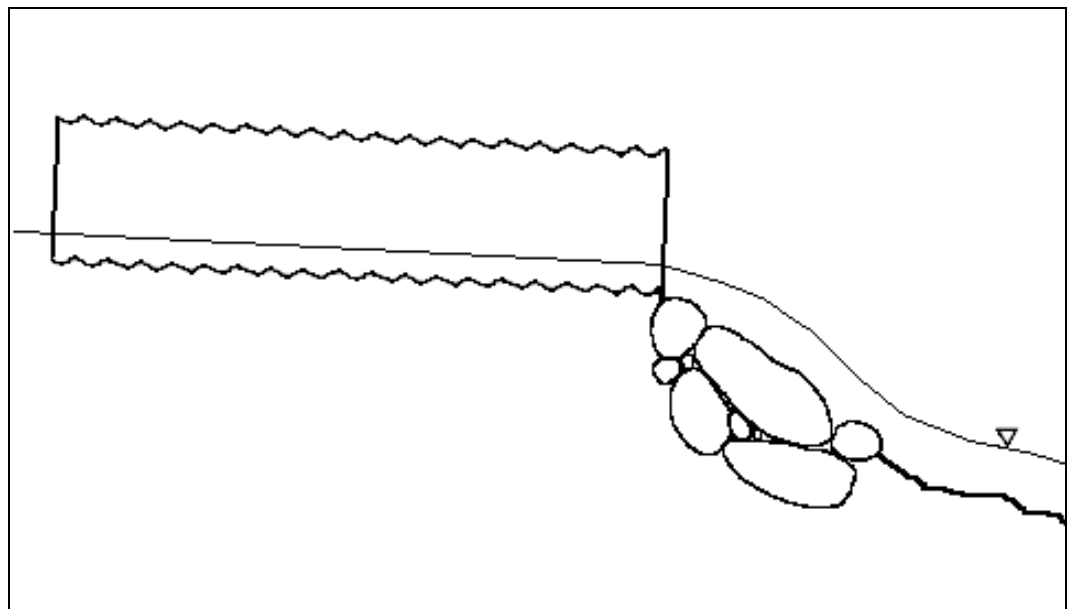

Figure 5-39: Cascade Over Riprap

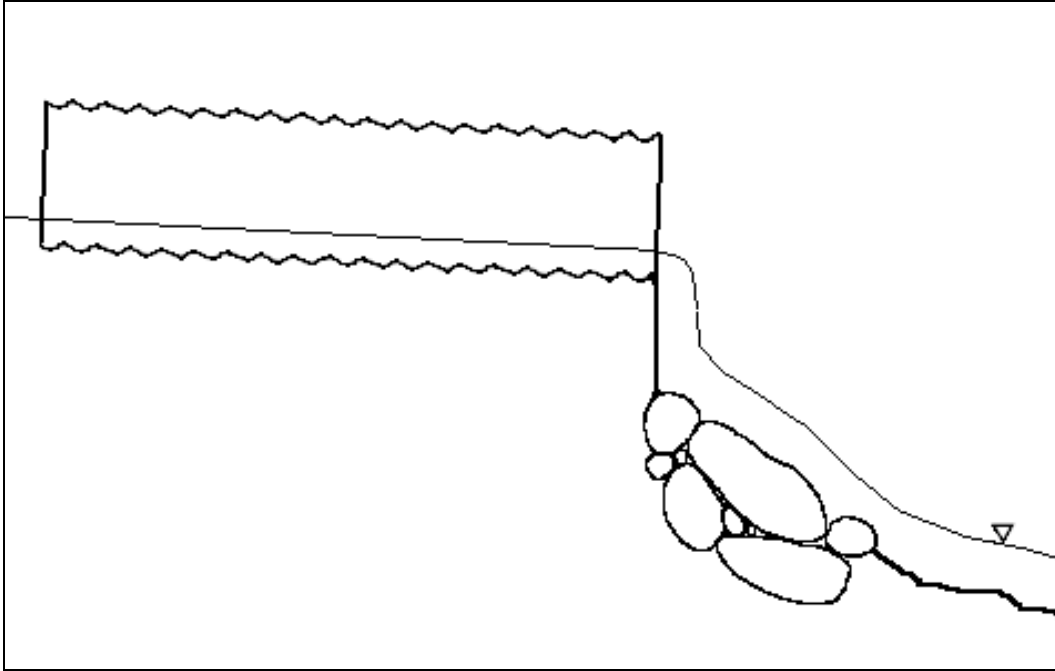

Figure 5-40: Free Fall Onto Riprap

An embedded culvert outlet indicates that the outlet invert is embedded below the natural stream bed. This condition covers the outlet invert with a substantial amount of stream substrate (figure 5-41).

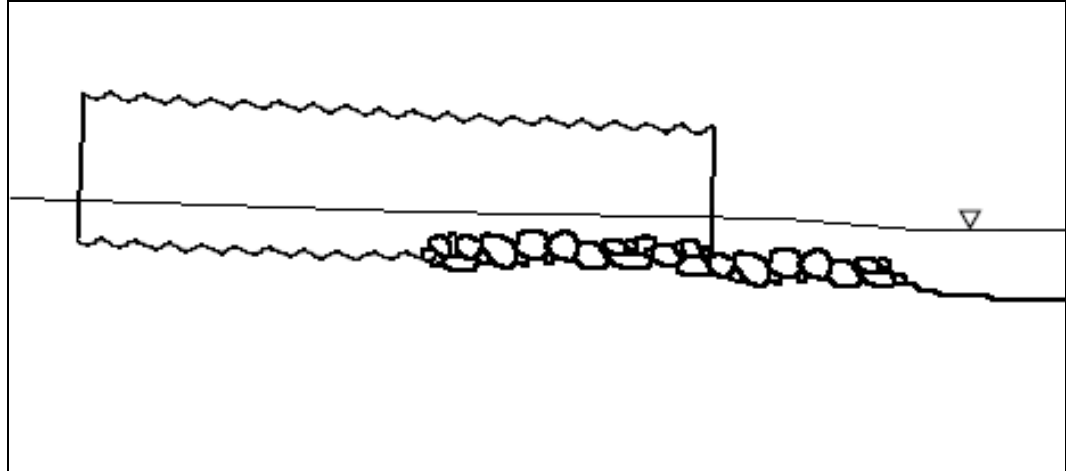

Figure 5-41: Embedded Culvert Outlet

5.6 Hydraulic Jump and Location

Hydraulic jumps represent a reduction or dissipation of energy in flowing/moving water. Jumps are normally located where faster moving water slows rapidly. Typically these jumps look like whitewater or a large stream riffle. Several illustrations of hydraulic jumps can be found in the figures 5-42 through 5-45.

Hydraulic jumps may also coincide with slope breaks inside the culvert barrel. Often the culvert is designed with a slope break to force a hydraulic jump to occur in the culvert. This keeps the outlet velocities lower and reduces scouring at or near the culvert outlet. If a hydraulic jump occurs within the culvert or near the inlet or outlet the approximate location should be annotated in the sketch portion of the field data sheet.



Figure 5-42: Hydraulic Jump Just Upstream of Inlet



Figure 5-43: Hydraulic Jump Just Inside Culvert Inlet



Figure 5-44: Hydraulic Jump Just Downstream of Outlet



Figure 5-45: Hydraulic Jump at End of Outlet Apron

The general location of the hydraulic jump should be annotated as, relative to inlet (upper 3rd), relative to mid-culvert (middle 3rd), and relative to the outlet (lower 3rd). If the jump occurs in the immediate vicinity of the inlet or outlet then the (inlet) or (outlet) box should be selected. In the sketch you should describe the location and distance from the inlet or outlet of the hydraulic jump. Exact measurements are not required.

5.7 Substrate Data

Data obtained for this section gives a general description of the substrate conditions inside the culvert. Assessment conditions include:

- Absent: No substrate observed anywhere throughout culvert
- Continuous: Substrate is continuous throughout the culvert (inlet to outlet)
- Single Patch: A single individual mass of substrate is observed in culvert that does not meet continuous criteria
- Patchy: More than one individual mass of substrate is observed in culvert

Examples of the single patch condition include:

- Substrate present at/near the inlet only
- Substrate present at/near the outlet only
- An isolated mass of substrate anywhere inside the culvert

Inlet:

- Absent: No substrate present at inlet
- Present: Substrate is present at inlet

Outlet:

- Absent: No substrate present at outlet
- Present: Substrate is present at outlet

Observed size:

- Boulders: > 10 inches
- Cobbles: 2.5 to 10 inches
- Gravel: 0.08 to 2.5 inches
- Sand: Grainy < 0.08 inches
- Fines: Non-grainy < 0.08 inches

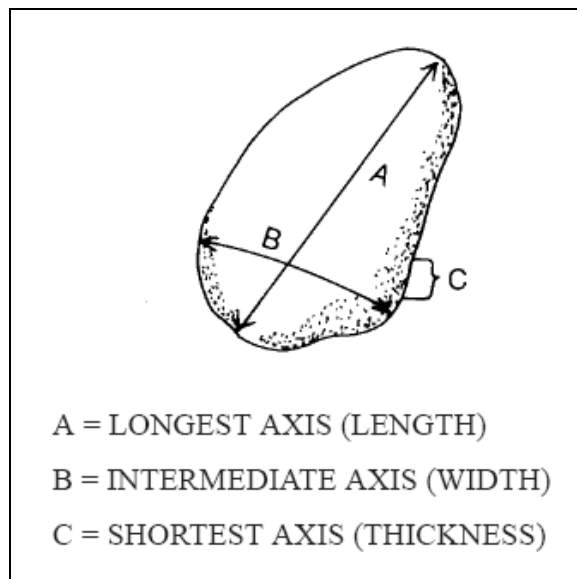

Figure 5-46: Measurement of the Intermediate Axis of Larger Substrate (Harrelson 1994)

Substrate size is obtained by taking several representative samples and measuring them along the intermediate axis (figure 5-46). In the notes you should describe the location of substrate and correlated sizes. Distances where substrate begins or ends related to the inlet or outlet should also be included in the notes. Exact measurements are not needed.

5.8 Longitudinal Survey

For technicians unfamiliar with longitudinal stream surveys, good sources of information regarding this type of survey are contained in the following documents:

- Stream Channel Reference Sites: an Illustrated Guide to Field Technique, (Harrelson 1994)
 - Section 5
 - Section 8
- FishXing Tutorial, (USFS 2008)
 - http://www.fs.fed.us/pnw/pep/PEP_inventory.html?x=1
 - Click On: “View the Presentation”
 - From the Menu on the Left Select: “Overview of the Longitudinal Profile”

These resources contain information, methods and techniques for performing longitudinal surveys in wadeable streams, as well as in depth information on basic stream morphology. Technicians with little or no stream surveying experience should familiarize themselves with these documents.

A brief explanation of stream morphology is presented here to understand several of the stations defined in the longitudinal survey (figure 5-47 & 5-48). Riffles represent shallow, fast, turbulent sections of stream channel. Pools represent the deepest slowest portions of stream and are usually devoid of turbulent flow.

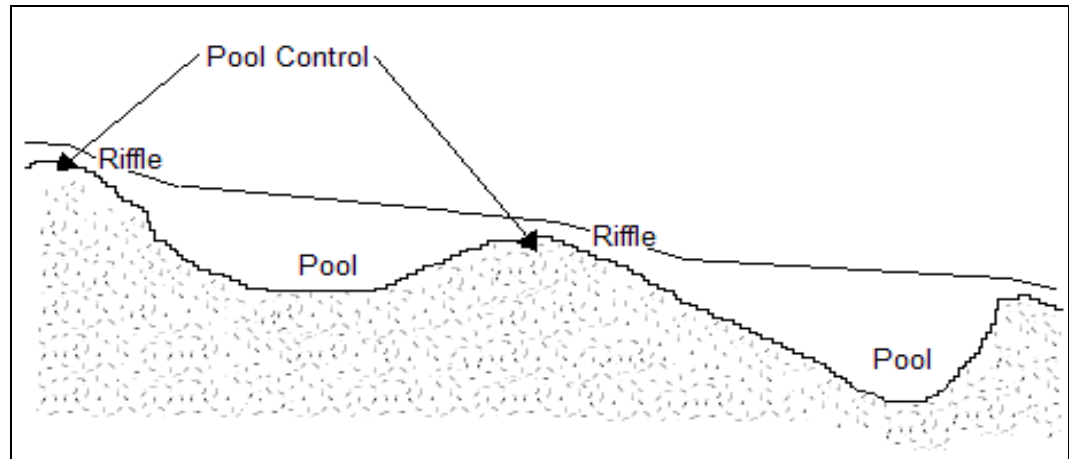

Figure 5-47: Basic Riffle/Pool Stream Morphology



Figure 5-48: Pool Control

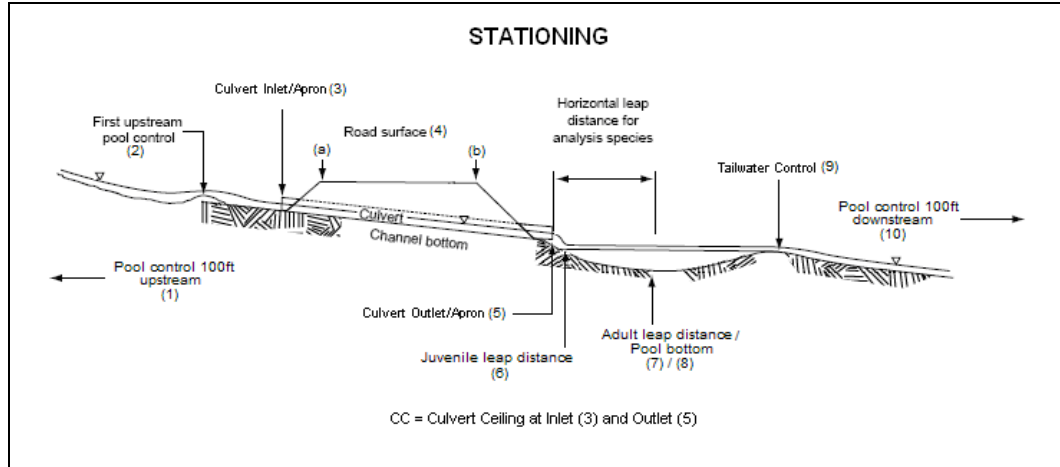

Figure 5-49: Stationing for Longitudinal Profile Survey (Modified Clarkin et al. 2003)

Longitudinal survey (figure 5-49) data is essential to evaluating the culvert/stream conditions for determining fish passage. The longitudinal survey is broken up into 10 common points. The points are categorized as P1, P2, and P3 etc. Special survey categories include:

- BM: Benchmark
- TP: Turning point
- CC: Culvert ceiling
- SB: Stream bed
- RS: Road Surface
- S: Slope break
- A: Apron

Longitudinal survey points:

- P1: A pool control approximately 100 ft upstream of the culvert inlet

- P2: First upstream pool control from culvert inlet
- P3: Culvert inlet invert
 - Possible P3 designations
 - P3-A: Apron edge at culvert inlet
 - P3-CC: Ceiling of culvert inlet
 - P3-SB: Stream bed elevation of culvert with embedded inlet
 - P3-BM: Benchmark taken at the middle of the culvert inlet invert
 - P3-S: Slope break between P3 and P5
 - If more than 1 slope break exists use the following notation
 - P3-S1, P3-S2, etc.
- P4a: Road surface at break in slope or road shoulder on upstream side of road
- P4b: Road surface at break in slope or road shoulder on downstream side of road
- P5: Culvert outlet invert
 - Possible P5 designations
 - P5-A: Apron edge at culvert outlet
 - P5-CC: Ceiling of culvert outlet
 - P5-SB: Stream bed elevation of culvert with embedded outlet
 - P5-BM: Benchmark taken at the middle of the culvert outlet invert
 - P5-S: Slope break between P3 and P5
 - If more than 1 slope break exists use the following notation
 - P5-S1, P5-S2, etc.

- P6: The point is taken approximately 0.5 ft downstream of the culvert outlet. When the culvert is perched this represents the point where smaller or juvenile target species will attempt to enter the culvert by leaping.
- P7: The point is taken a known distance downstream of the culvert outlet invert. This distance is correlated to the leaping distance of adult or larger target species.
- P8: The point is taken at the deepest point of the pool immediately below the culvert outlet. When the culvert is perched this represents the point where adult target species will attempt to enter the culvert by leaping; often P7 = P8.
- P9: This is termed the tailwater control point. This is the point in the channel immediately downstream of the culvert outlet which controls the backwatering or the depth of flow in the culvert. Essentially this is the first pool control downstream of the culvert outlet. This point is located at the lowest elevation of the channel cross section at the tailwater control.
- P10: A pool control approximately 100 ft downstream of the culvert outlet.
- TP-RS: Usually a turning point on the road shoulder

5.8.1 Benchmark

A relative benchmark for the survey is assigned and recorded at the inlet or outlet invert. The survey rod height is also recorded. Benchmarks are taken in the middle of the inlet or outlet invert. When calculating relative elevations a good method is to assign the benchmark a value of 100 feet.

5.8.2 Accuracy

Elevations should be recorded on the assessment field data sheet to at least a hundredth of a foot. This reflects the accuracy with which the slope should be calculated and reported later in the assessment. Fish passage criteria are very sensitive to culvert slope so this measurement should be as precise and accurate as possible.

5.8.3 Set Up

Taking assessment photos prior should give you a good feel for the channel/culvert orientation. Often if the channel and culvert line up accordingly you can perform the whole survey from one location. When possible this location should be just downstream of the tailwater control point or P9. This will allow you to get both the longitudinal and cross section survey data without having to move your equipment.

The survey can be initiated at any point in the stationing. Common turning points are points P3, P4a, P4b and P5. These points represent places in the stationing which lend themselves well to also being a turning point.

5.8.4 Embedded Culverts

When the culvert is embedded to any degree that obtaining the elevation of either the inlet invert or outlet invert is not feasible, you can determine the slope of the culvert by determining the relative elevation of the inlet and outlet ceilings (P3-CC & P5-CC). This is performed by turning the survey rod upside down, placing the foot of the survey rod on the ceiling of the culvert and recording the elevation of inlet and outlet ceiling.

The difference of these two points will allow you to calculate the elevation differential used to calculate the physical culvert slope. Only use this data to calculate

the culvert slope during the field calculations portion of the assessment, not to identify the relative culvert ceiling elevation. Relative elevations of the culvert are not required.

Notate embedded inverts as 3P-SB or 5P-SB to describe the point elevation is related to the streambed/substrate elevation and not the actual invert elevation. For embedded conditions most often the inlet invert will not be embedded, but the outlet invert will be.

5.9 Stream Slope Distances

Stream slope distances between survey points can be calculated by the survey equipment or by hand and then recorded. If survey equipment is being used which will not perform this calculation on site a 300 ft. fiberglass tape is used to determine the horizontal distances between survey points. The rod holder should have a shoulder bag with a 300 ft. tape and landscape flags. Each point in the survey should be marked on the stream bank with a landscape flag. After the survey is performed the horizontal distance between landscape flags is determined. Horizontal distances are taken as the actual curved stream distance following the deepest sections of the stream (thalweg). Often larger rocks and survey stakes can be utilized to anchor the fiberglass tape to the thalweg for determining these horizontal distances of the stream.

Horizontal distances which need calculating are those between points (P1 & P2), (P2 & P3), (P3 & P5), and (P9 & P10). This means that at least four landscape flags may be utilized in this portion of the survey.

5.10 Field Calculations

This section is to aid team members in making calculations associated with the fish screen used for assigning the fish passage status of the culvert. Team members should familiarize themselves with the equations and the calculators they will be making them with to ensure reliable calculations/results in the field.

Slope in %:

$$\frac{P_x - P_y}{dist_{x \rightarrow y}} \times 100 = Slope_{x \rightarrow y} \quad (5-1)$$

where:

P_x = Elevation of Upstream Point in Feet

P_y = Elevation of Downstream Point in Feet

$dist_{x \rightarrow y}$ = Stream slope distance in feet between P_x and P_y

Outlet Drop:

$$P_5 - P_9 = \text{Outlet Drop} \quad (5-2)$$

where:

P_5 = Elevation of Outlet Invert in Feet

P_9 = Elevation of Outlet/Tailwater Control in Feet

Residual Inlet Depth:

$$P_9 - P_3 = \text{Residual Inlet Depth} \quad (5-3)$$

where:

P_9 = Elevation of Outlet/Tailwater Control in Feet

P_3 = Elevation of Outlet Invert in Feet

Length/Slope Product:

$$\text{CulvertLength}(ft) \times \text{CulvertSlope}(\%) = \text{Length Slope Product} \quad (5-4)$$

where:

CulvertLength = Culvert Length in Feet

CulvertSlope = Culvert Slope in %

Data evaluation:

- Negative slopes indicate an uphill slope between the two evaluated longitudinal points
- Positive outlet drop values indicate that the culvert is perched
- Positive residual inlet depth values indicate that the culvert is completely backwatered.

5.11 Fish Passage Status

The fish passage assessment provides a procedural method for deriving a culvert's ability to provide upstream passage for fish. The assessment comprises collecting data relative to the physical characteristics of the culvert itself, morphologic responses of the stream channel, surrounding topography, and hydraulic characteristics of both the culvert and stream channel.

These fish screens have been developed correlating observational data (known/observed fish passage) with culvert and stream relationships/characteristics. Screens have been developed along functional group specific lines to evaluate passage correlations between the culvert/stream relationships and the targeted group of fish.

Culvert assessment data is evaluated with flow charts (fish screens) describing certain culvert/stream conditions under which fish may or may not pass successfully upstream. The fish passage status of the culvert is categorized by the fish screen for the intended species.

There are three screens which provide fish passage data for four categories of fish:

- Adult Salmonids (Trout)
- YOY Salmonids (Trout)
- Cyprinidae (Mid-water Minnows)
- Benthic (Smaller bottom dwelling fishes)

The fish screens classify culverts using the following color coded classifications:

- RED = Assumed failure to pass target specie and life stage
- GREY = Unknown passage of target specie and life stage
- GREEN = All target specie at target life stage are assumed to pass

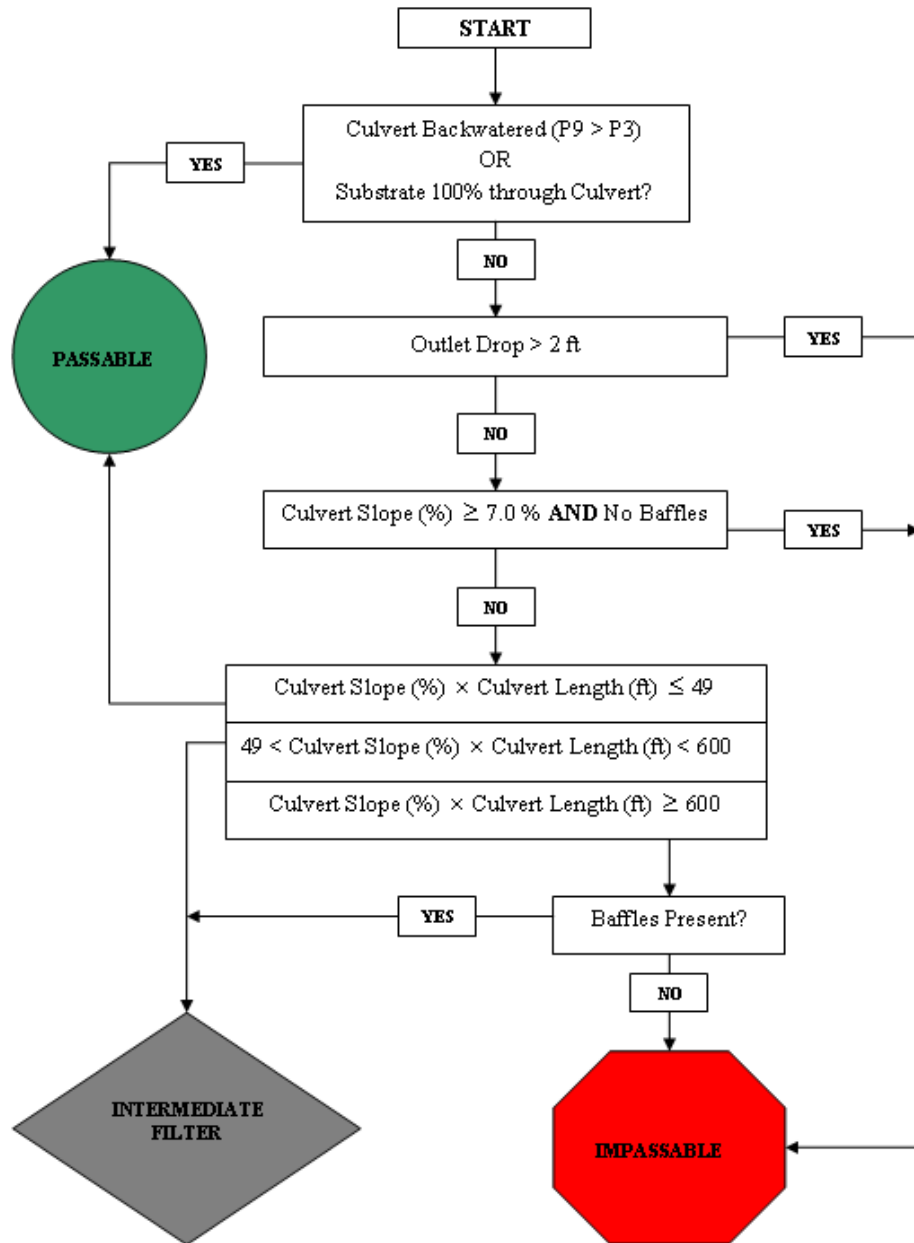

Figure 5-50: Adult Salmonid Fish Screen (Modified Coffman 2005)

The original screens were developed through research performed by Joseph Coffman of James Madison University. Using the data obtained from the field calculations you can follow the flow chart provided in each fish screen. Based on the

flow chart check the appropriate status box of GREEN, GREY or RED for the culvert you are assessing.

5.12 Further Analysis of GREY Status Culverts

The industry standard for further analyzing culverts classified as GREY occurs by taking data from the culvert assessment form and populating a FishXing model (Pronounced Fish-Crossing) (Love et al. 1999). FishXing is a free software application produced by the USFS which models culvert hydraulics and selected fish swimming/leaping ability. FishXing evaluates a fish's ability to successfully circumvent the culvert hydraulics through a range of input flows. If a fish's modeled navigation does not successfully pass through the culvert at the desired flows the culvert is then classified as a barrier (RED). If the fish successfully traverses the culvert the culvert is then classified as a non-barrier (GREEN). FishXing is available by download at the following web site:

- <http://www.stream.fs.fed.us/fishxing/download.html>

Fish baffles create complex culvert hydraulics. The fish passage assessment procedure is designed to predict a passage status for culverts possessing gradually varied flow conditions. Any culvert setting representing rapidly varied flow conditions requires the use of a "specialized" filter. Data to perform an assessment under these specialized conditions lies outside the scope of this assessment. Such specialized filters include fish tracking methods (such as radio telemetry), hydraulic software capable of modeling rapidly varied flow conditions, and observational/physical data (such as mark and recapture).

For cases where culverts contain fish baffles a unique assessment should be tailored made for the culvert site. A significant amount of additional data not found on the current fish passage assessment field data sheet will likely be required to correctly populate such a model. Due to the increased amount and complexity of the data required it's recommended that a special assessment team perform an individualized assessment. UDOT personnel familiar with fish passage design should create an original fish passage plan of assessment based on the particular conditions at the culvert site. This assessment team should include a member expert in fish passage hydraulics and the software being utilized.

5.13 Hydraulic Calibration

This section of the assessment is conducted when a culvert fish passage status of GREY is determined by the appropriate fish screen for the appropriate specie of concern AND fish baffles are not present in the culvert.

Calibration has been shown to greatly increase the accuracy of the culvert hydraulic modeling software FishXing in predicting fish passage. As an example 1510 days of non-passage predicted by FishXing was reduced to 173 days of non-passage calibrating FishXing with a known discharge and corresponding water depths (Blank 2006). The data contained in this section of the field data form can be utilized to calibrate hydraulic models capable of modeling gradually varied flow culvert conditions.

Data specific to this procedure are used to populate models using the software FishXing. Data calculated from the assessment useful in calibrating these hydraulic models are:

- Manning's n value for culvert
- Manning's n value for tailwater section of channel
- General location of hydraulic jump
- Water surface slope of culvert
- Depth of water at inlet and outlet
- Average velocities of inlet, mid-culvert and outlet

A Microsoft Excel file has been generated to provide engineers a calculation space to facilitate these calculations. All of the data in the assessment is populated in this file (Fish_passage_calibration.xls). This file also allows for electronic storage of the fish passage assessment data.

5.13.1 Tailwater Cross Section Survey

This survey must be taken relative to the benchmark used for the longitudinal survey so the two survey's elevations are connected. For technicians unfamiliar with stream cross section surveys, good sources of information regarding this type of survey are contained in the following documents:

- Stream Channel Reference Sites: an Illustrated Guide to Field Technique, (Harrelson 1994)
 - Section 5
 - Section 6
- FishXing Tutorial, (USFS 2008)
 - http://www.fs.fed.us/pnw/pep/PEP_inventory.html?x=1

- Click On: “View the Presentation”
- From the Menu on the Left Select: “Tailwater Cross Section”

These resources contain information, methods and techniques for performing stream cross section surveys as well as in depth information on basic stream morphology. The online tutorial is extremely helpful as it specifically discusses the type of tailwater control cross section survey utilized in this assessment. Technicians with little or no experience in this type of surveying should familiarize themselves with both of these documents.

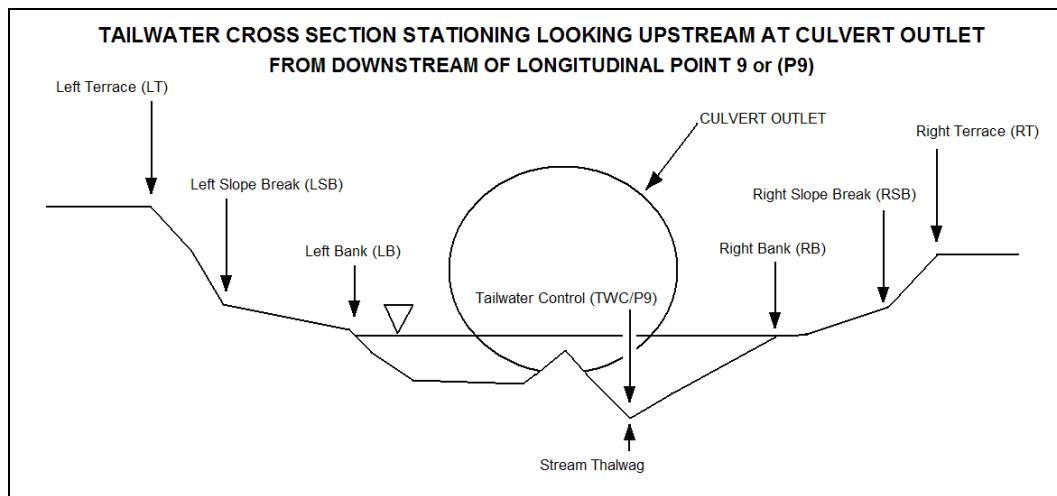

Figure 5-51: Stationing for Tailwater Cross Section Survey

Tailwater cross section survey data can be used for populating a hydraulic model for assessing the fish passage status of culverts. The survey is broken up into 5 minimum points. These points are categorized in figure 5-51. The minimum points in the survey include:

- LT: Left terrace
- LB: Left bank
- TWC/P9: Tailwater Control (From Longitudinal Survey Profile)
- RB: Right bank
- RT: Right Terrace

Additional points may include:

- RSB: Right slope break
- LSB: Left slope break
- Additional stream bed points

This cross section survey is performed at the longitudinal survey point P9 or tailwater control. The survey is taken perpendicular to the channel flow downstream of the culvert outlet. The orientation of the survey relative to the culvert is facing upstream toward the culvert outlet with the survey equipment below the tailwater control point or P9. Stationing begins from zero at the left terrace and moves across the channel ending at the right terrace. Cross section stations are recorded as the horizontal distance in feet from the left bank.

If the streambed is highly channelized (very steep stream bank slopes) then points RSB and LSB will be omitted. This is due to absence of any slope break between the terrace and the stream bank.

Between the left (LB) and right banks (RB) survey points, additional points should be taken at prominent/noticeable changes in the stream cross section elevation.

Typically no more than 4 or 5 points (other than the tailwater control point) need to be surveyed between the points LB and RB. Often this cross section is relatively rectangular.

5.13.2 Calculating Discharge

The material used to train technicians on the correct method of calculating stream discharge in wadeable streams is contained in the following documents:

- Stream Channel Reference Sites: an Illustrated Guide to Field Technique, Harrelson (1994)
 - Section 10
- USGS Tutorial (USGS 2008)
 - <http://wwwrcamnl.wr.usgs.gov/sws/SWTraining/WRIR004036/Index.html>

Together these documents outline several methods utilized with different equipment for calculating discharge in wadeable streams.

The USDA document provides sufficient background, information and methods for determining discharge using hand held meters of various types. The USGS resource covers a wide array of discharge calculation techniques as well as quality control methods for the equipment utilized in these techniques. The USGS web-site also provides an online test of techniques and topics covered in the training, as well as a certificate of completion upon successfully passing the end of training test.

It's recommended that the technicians read and familiarize themselves with the USDA document and then participate in the USGS online training, a successful

completion of the USGS test should indicate that technicians have sufficient training to be able to calculate discharge in wadeable streams in the field.

Field data recorded on the assessment field data sheet is consistent with the methods and data used for calculating discharge with hand-held current meters and digital velocity meters presented in the USDA and USGS documents. These hand held methods represent the standard for calculating discharge in wadeable streams.

Stream cross section stationing used for calculating discharge are recorded as the horizontal distance in feet from the left bank. Stationing begins on the left bank (looking upstream) at 0 ft. and moves to the right bank.

5.14 Site Sketch

Refer the reference sketch in Appendix C for additional clarification. The site sketch should include the following:

- North Arrow
- Direction of Stream Flow Arrow
- Culvert/Channel/Road Alignment
- Photo Locations
- Cross Section Location
- Baffle location
- Hydraulic Jump location
- Head/Wingwall/Apron Configuration
- Riprap location
- Slope Break location

- Substrate Location/Details
- Other Structures

5.14.1 Culvert/Channel/Road Alignment

The sketch should include the general alignment of the stream channel and roads or highways crossing it. This should include frontage roads, irrigation ditches and any other type of crossing which intersects the stream channel at/near the culvert site. Label crossings with an appropriate label. For roads and highways use the state identifier such as “HWY 40” or “I-15”.

5.14.2 Photo Locations

Photos are sketched by writing the photo number, and then drawing a circle around the number at the location the photo was taken.

5.14.3 Baffles

Shade the area of the culvert containing baffles and identify the shaded area with the label “Baffles”. The label should identify the location with an arrow. Often baffles will only traverse a portion of the cross section of a culvert. Sometimes they span the entire cross section of the culvert. Shade the appropriate amount of culvert as needed.

5.14.4 Head/Wingwall/Apron Configuration

Sketch the general orientation and geometric shapes of these structures relative to the culvert. Try to provide a realistic portrayal of the different shapes and orientations.

5.14.5 Riprap

Sketch riprap by drawing multiple triangles representing the many different single elements of the riprap. Sketch these triangles in the general location they are found relative to the culvert. Identify the riprap with the appropriate label “Riprap”. The label should identify the location with an arrow.

5.14.6 Locations

The following locations may be represented by marking the locations on the sketch with a large “X” and identifying them with the appropriate label. The label should identify the location with an arrow. Labels are as follows:

- Tailwater Control – “TWC”
- Hydraulic Jump – “Jump”
- Slope Break – “Break”
- Structures/Conditions – Use appropriate label describing additional structures and conditions

References

- Blank, M., Cahoon, J., Burford, D., McMahon, T., and Stein, O. (2006) "Studies of Fish Passage through Culverts in Montana", 2005 International Conference on Ecology and Transportation, Center for Transportation and the Environment, North Carolina State University, Raleigh
- Clarkin, K., A. Conner, M. J. Furniss, B. Gubernik, M. Love, K. Moynan, and S. Wilson Musser (2003). *National Inventory and Assessment Procedure for Identifying Barriers to Aquatic Organism Passage at Road-stream Crossings*, U.S. Forest Service.
- Coffman, J. S. *Evaluation of a Predictive Model for Upstream Fish Passage through Culverts*, Master's Thesis, James Madison University, 2005.
- FHWA (2007). "WinHY8: Program Help Menu." Version 7.1. Federal Highway Administration, Washington, DC.
- Harrelson, C. C., Rawlins, C. L., and Potyondy, J. P. (1994). "*Stream Channel Reference Sites: an Illustrated Guide to Field Technique*." USDA FS GTR RM-245, Rocky Mountain Forest and Range Experiment Station, Ft Collins, CO.
- Love, M., Firor, S., Furniss, M., Gubernick, R., Dunklin, T., and Quarles, R. (1999). FishXing (Version 2.2). Six Rivers National Forest Watershed Interactions Team, USDA Forest Service, San Dimas Technology and Development Center, San Dimas, California. www.stream.fs.fed.us/fishxing.
- USFS (2006). "FishXing: User Manual and Reference." Version 3.0. U.S. Forest Service.
- USFS (2008). FishXing Web Site: "A Tutorial on Field Procedures for Inventory and Assessment of Road-Stream Crossings for Aquatic Organism Passage." <http://www.stream.fs.fed.us/fishxing/PEPs.html>
- USGS (2008). Web Site: "Measurement of Stream Discharge by Wading." <http://wwwrcamnl.wr.usgs.gov/sws/SWTraining/WRIR004036/Index.html>

WDFW (2000). “*Fish Passage Barrier and Surface Water Diversion Screening Assessment and Prioritization Manual.*” Washington Department of Fish and Wildlife, Olympia, WA.

Appendix A Fish Passage Assessment Field Data Sheets

FISH PASSAGE ASSESSMENT FIELD DATA SHEET

Surveyor Names: _____ Field Date: ____/____/____

SITE

UDOT Region: _____ Route #: _____ Milepost #: _____ Stream Name: _____

GPS: (Lat): _____ (Long): _____ Coordinate System: _____ Units: _____

PHOTOS: Provide Photo #'s, Locations, and Shot Orientation in Sketch

- (1) Embankment Looking Upstream (2) Embankment Looking Downstream
 (3) Looking at Outlet (4) Internal Culvert Structures (5) Slope Break in Culvert (6) Looking at Inlet
 (7) Instream Structures (8) Bank Stabilization Structures (9) Local Erosion (10) Local Failures
 (11) Other: _____

CULVERT DATA:

Physical: Length: _____ (ft) Rise: _____ (ft) Span: _____ (ft) Diameter: _____ (ft)

Scour width: _____ (ft) Scour length: _____ (ft)

Corrugation (height): _____ (in.) (width): _____ (in.)

Material: Steel Aluminum Plastic Concrete Other: _____

Shape: Box Circular Pipe Pipe-arch (Squash Pipe) Horizontal Ellipse Arch Arch Box

Roughness: Smooth Corrugated Annular Corrugated Spiral Plated Paved Baffles Slope Breaks

Inlet: Projected Mitered Headwall Wingwall (10-30 Deg) Wingwall (30-70 Deg) Apron Embedded

Inlet Edge Conditions: Grooved Edge Square Edge Beveled Edge

Outlet: At stream grade Perched Cascade Riprap Freefall Embedded Apron

Hydraulic Jump: Absent Present

Hydraulic Jump Location: Inlet Outlet Upper 3rd Middle 3rd Lower 3rd

SUBSTRATE DATA: Provide Substrate Characteristics and Geometry in Sketch

Condition: Absent Continuous Single Patch Patchy

Inlet: Absent Present Outlet: Absent Present

Observed Size: Boulders Cobble Gravel Sand Fines

Notes: _____

Figure A-1: Page 1 Fish Passage Assessment

FIELD CALCULATIONS

Culvert Slopes: Invert Slope $_{3=5}$: _____ (%) Ceiling Slope $_{3Top=5Top}$: _____ (%)

Inlet/Outlet Depth/Drop: Residual Inlet Depth: _____ (ft) Outlet Drop: _____ (ft)

Culvert Length/Slope Product: Culvert Length (ft) X Culvert Slope (%): _____ (ft)

CULVERT FISH PASSAGE STATUS

ADULT SALMONID STATUS: RED GREEN GREY

YOY SALMONID STATUS: RED GREEN GREY

CYPRINIDAE STATUS: RED GREEN GREY

BENTHIC STATUS: RED GREEN GREY

HYDRAULIC CALIBRATION (Only Perform for Passage Status of GREY when Baffles are NOT Present)

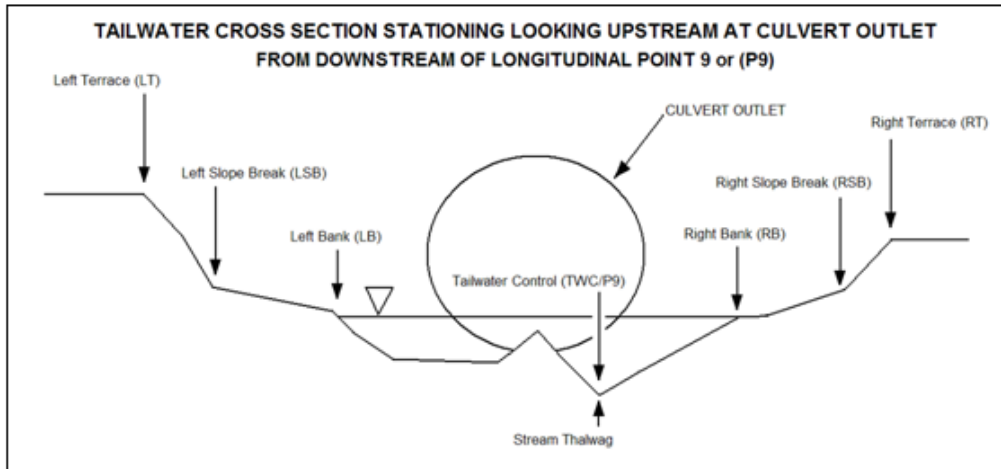

Tailwater Cross Section Looking upstream to Point 9: Stationing is from Left bank to Right bank

Station	BS (+)	HI	FS(+)	Elevation	Notes	Station Points
						LT
						LSB
						LB
						TWC/P9
						RE
						RSB
						RT

Figure A-3: Page 3 Fish Passage Assessment

SITE SKETCH:

- North Arrow
- Direction of Stream Flow
- Culvert/Channel/Road Alignment
- Photo Locations
- Cross Section Location
- Baffle location
- Hydraulic Jump
- Head/Wingwall/Apron Configuration
- Riprap
- Slope Breaks
- Substrate Details
- Other Structures



Orientation

Figure A-5: Page 5 Fish Passage Assessment

Appendix B Fish Screens

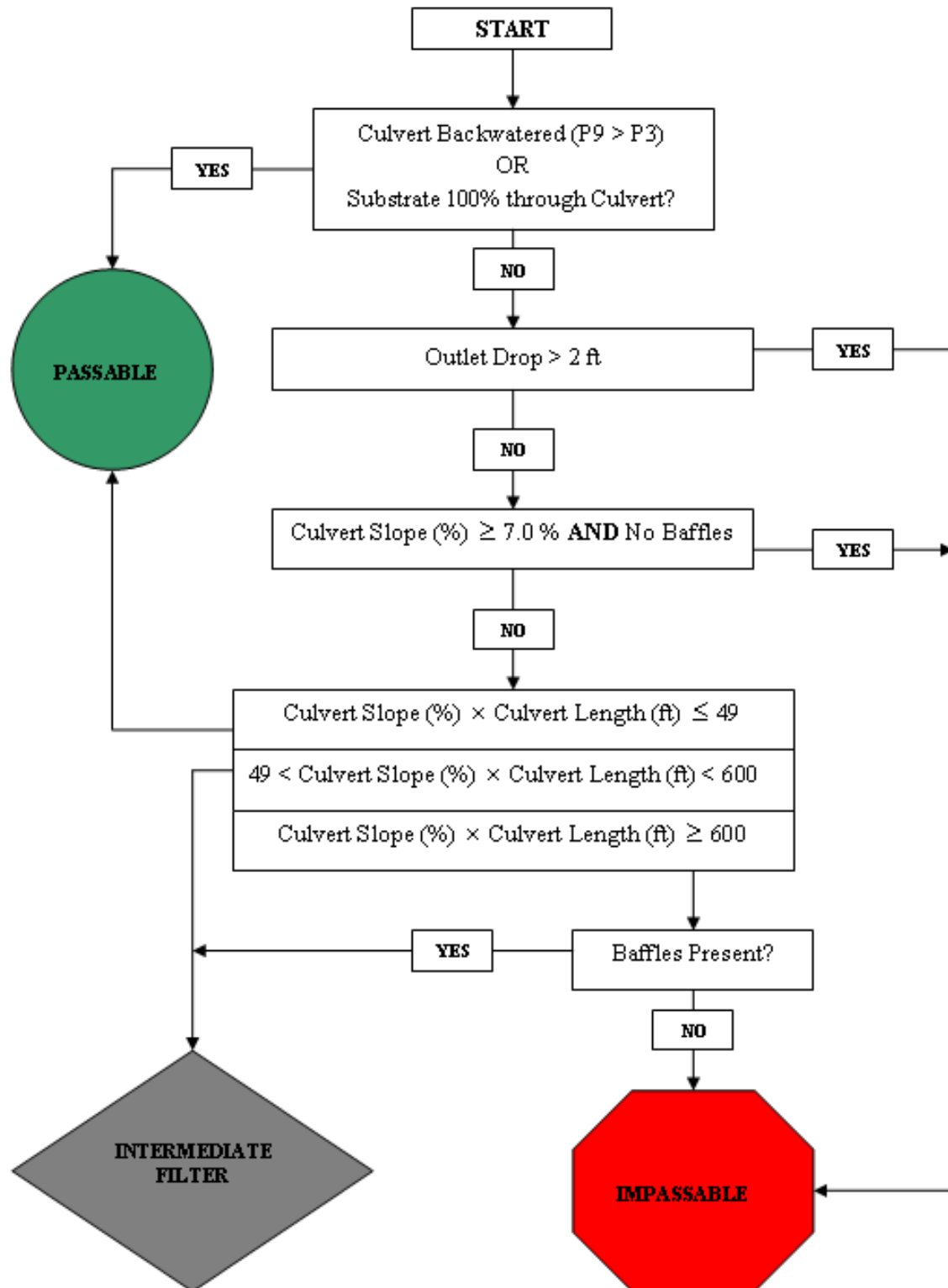

Figure B-1: Adult Salmonid Fish Screen

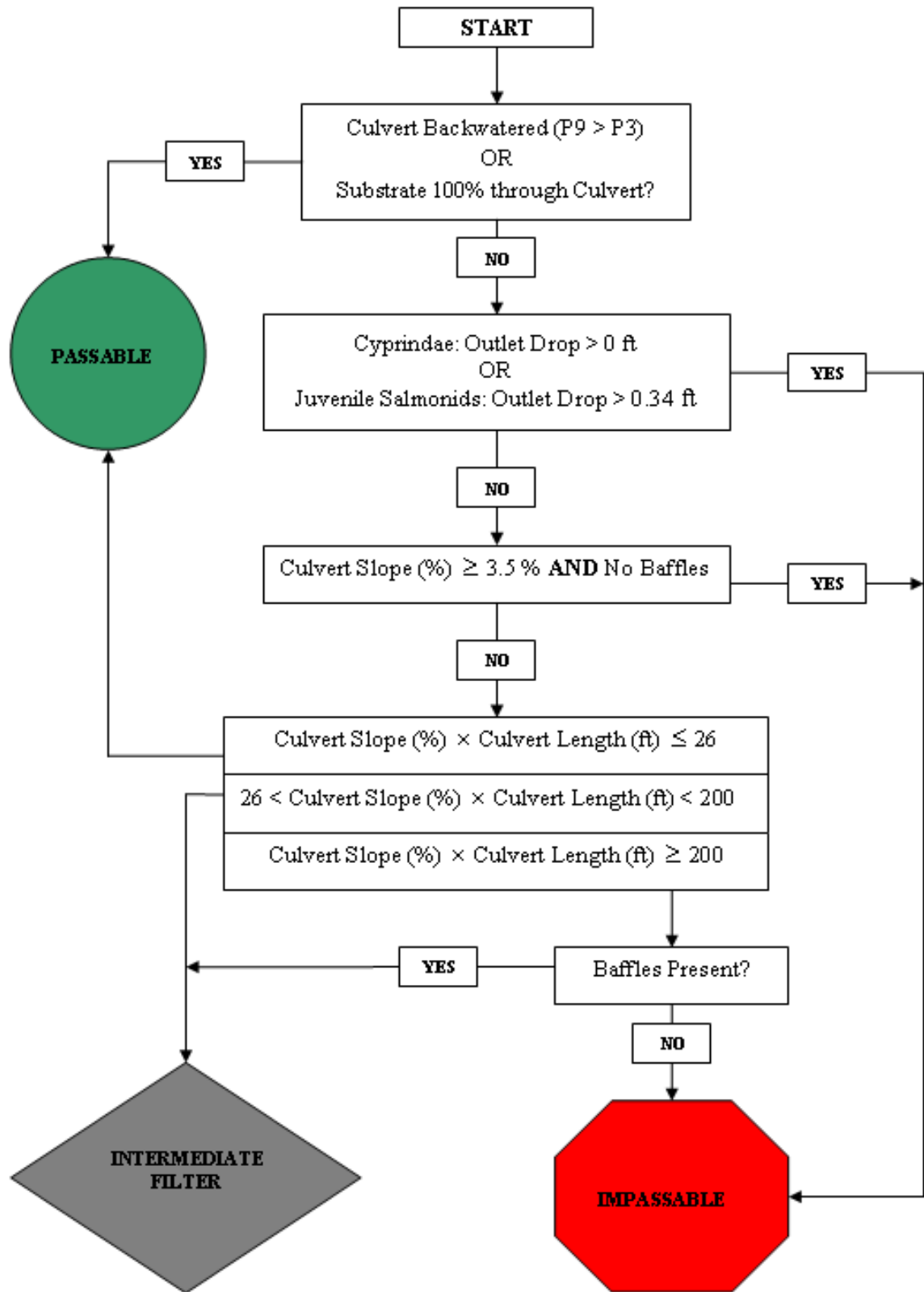

Figure B-2: Young of Year Salmonid and Cyprinidae Fish Screen

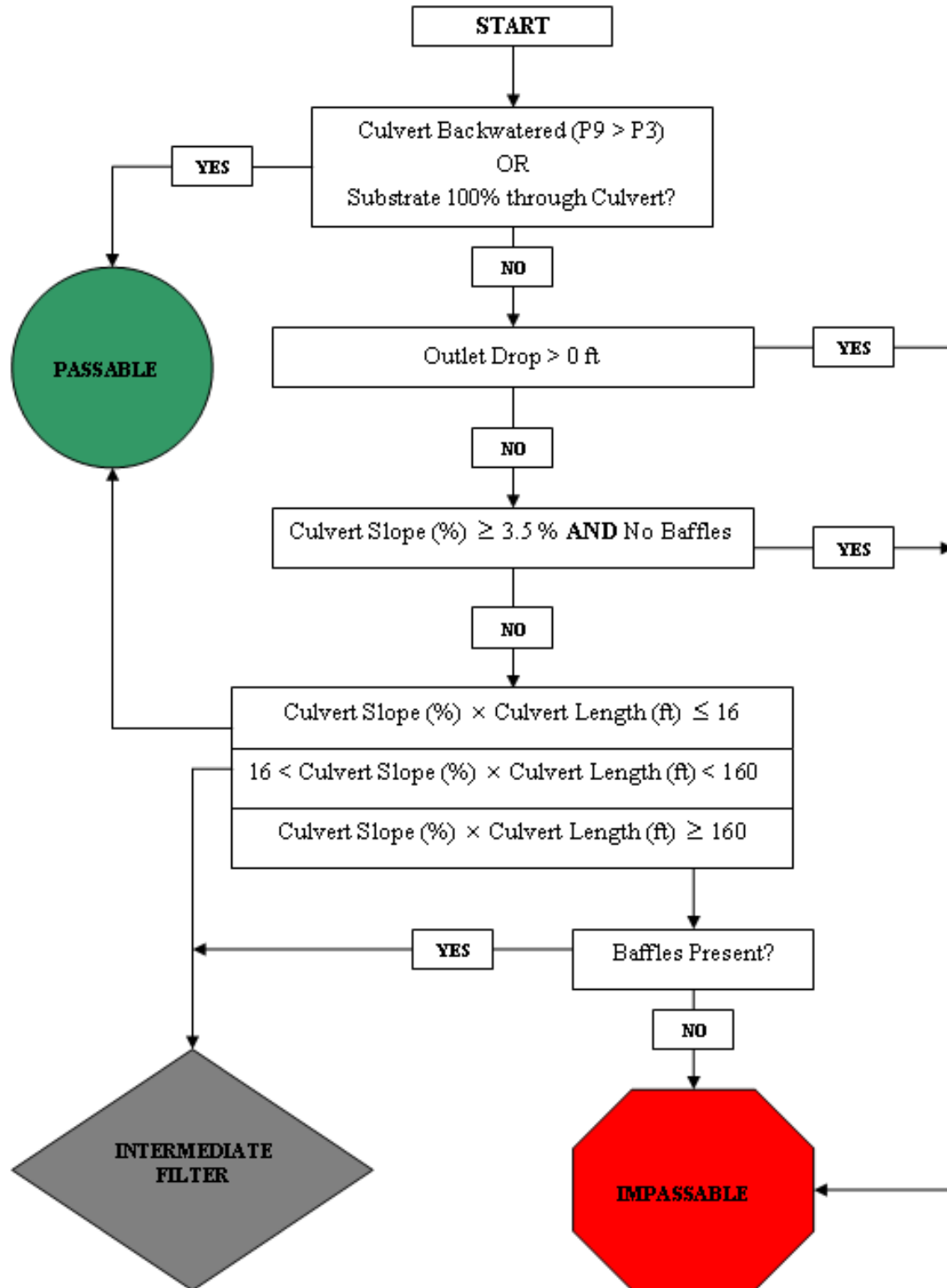

Figure B-3: Benthic Fish Screen

Appendix C Example Field Data Sheet

Surveyor Names: Ethen Beavers, John Smith Field Date: 04/01/08

SITE

UDOT Region: Central Route #: I-15 Milepost #: UKW Stream Name: Aaron's Creek

GPS: (Lat): 39.99365 (Long): 111.493941 Coordinate System: WGS 84 Units: Decimal Degrees

PHOTOS: Provide Photo #'s, Locations, and Shot Orientation in Sketch

- (1) Embankment Looking Upstream (2) Embankment Looking Downstream
- (3) Looking at Outlet (4) Internal Culvert Structures (5) Slope Break in Culvert (6) Looking at Inlet
- (7) Instream Structures (8) Bank Stabilization Structures (9) Local Erosion (10) Local Failures
- (11) Other: _____

CULVERT DATA:

Physical: Length: 600 (ft) Rise: _____ (ft) Span: _____ (ft) Diameter: 17.5 (ft)

Scour width: 24 (ft) Scour length: 450 (ft)

Corrugation (height): 2 (in.) (width): 6 (in.)

Material: Steel Aluminum Plastic Concrete Other: _____

Shape: Box Circular Pipe Pipe-arch (Squash Pipe) Horizontal Ellipse Arch Arch Box

Roughness: Smooth Corrugated Annular Corrugated Spiral Plated Paved Baffles Slope Breaks

Inlet: Projected Mitered Headwall Wingwall (10-30 Deg) Wingwall (30-70 Deg) Apron Embedded

Inlet Edge Conditions: Grooved Edge Square Edge Beveled Edge

Outlet: At stream grade Perched Cascade Riprap Freefall Embedded Apron

Hydraulic Jump: Absent Present

Hydraulic Jump Location: Inlet Outlet Upper 3rd Middle 3rd Lower 3rd

SUBSTRATE DATA: Provide Substrate Characteristics and Geometry in Sketch

Condition: Absent Continuous Single Patch Patchy

Inlet: Absent Present Outlet: Absent Present

Observed Size: Boulders Cobble Gravel Sand Fines

Notes: Gravel begins 20ft inside inlet and ends 20ft inside

outlet

Figure C-1: Fish Passage Assessment Example Page 1

FIELD CALCULATIONS

Culvert Slopes: Invert Slope $_{3 \Rightarrow 5}$: 0.267(%) Ceiling Slope $_{3Top \Rightarrow 5Top}$: _____ (%)

Inlet/Outlet Depth/Drop: Residual Inlet Depth: 0.674 (ft) Outlet Drop: -2.27 (ft)

Culvert Length/Slope Product: Culvert Length (ft) X Culvert Slope (%): 159.7 (ft)

CULVERT FISH PASSAGE STATUS

ADULT SALMONID STATUS: RED GREEN GREY

JUVENILE SALMONID STATUS: RED GREEN GREY

CYPRINIDAE STATUS: RED GREEN GREY

SMALL BENTHIC STATUS: RED GREEN GREY

HYDRAULIC CALIBRATION (Only Perform for Passage Status of GREY when Baffles are NOT Present)

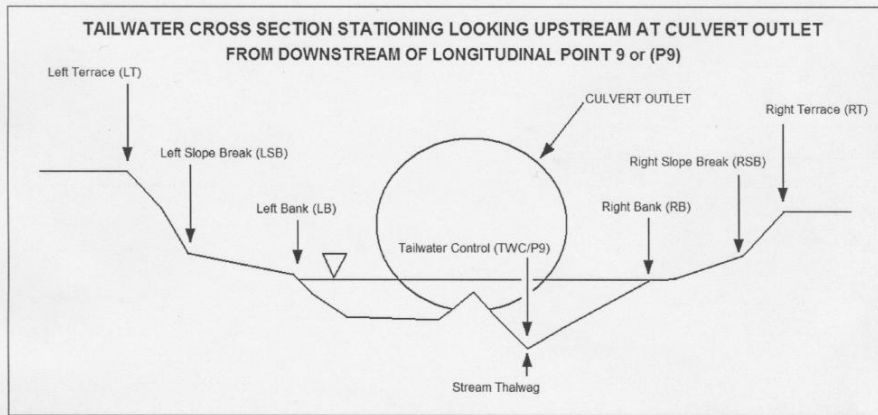

Tailwater Cross Section Looking upstream to Point 9: Stationing is from Left bank to Right bank

Station	BS (+)	HI	FS(+)	Elevation	Notes	Station Points
0	10.0				LT	LT
5	1.5				LSB	LSB
10	0.5				LB	LB
12	0.3				channel	TWC/P9
16	-0.1				channel	RB
18	-0.5				channel	RSB
20	-1.086		100.674		TWC/P9 - see longitudinal profile survey	RT
25	0.5				RB	
35	0.9				RSB	
40	4.0				RT	

Figure C-3: Fish Passage Assessment Example Page 3

CULVERT CONVEYANCE CROSS SECTION AREA

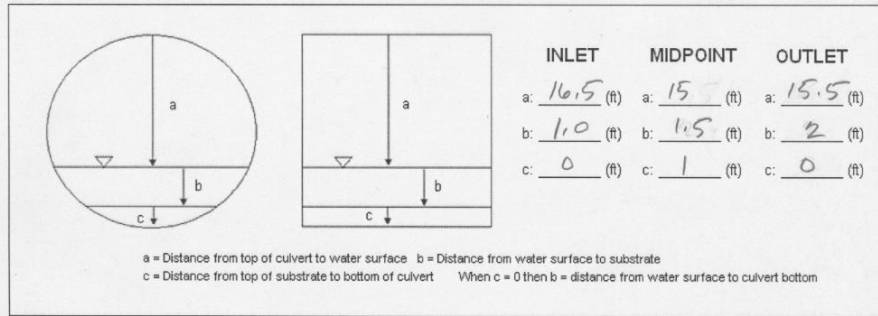

Discharge

Station (ft)	Width (ft)	Depth (ft)	Area (ft ²)	Revs (#)	Secs (#)	Velocity (ft/s)	Discharge (ft ³ /s)
0	0	0	0	0	0	0	0
0.5	1	0.5	0.5	5	40	0.29	0.15
1.5	1	0.8	0.8	20	40	1.12	0.90
2.5	1	1.0	1.0	22	40	1.23	1.23
3.5	1	1.1	1.1	25	40	1.39	1.54
4.5	1	1.0	1.0	26	40	1.45	1.45
5.5	1	1.2	1.2	24	40	1.34	1.61
6.5	1	1.0	1.0	23	40	1.29	1.29
7.5	1	1.0	1.0	25	40	1.40	1.40
8.5	1	1.3	1.3	28	40	1.56	2.03
9.5	1	1.9	1.9	24	40	1.34	2.54
10.5	1	1.9	1.9	23	40	1.28	2.44
11.5	1	1.9	1.9	21	40	1.17	2.23
12.5	1	1.9	1.9	20	40	1.12	2.13
13.5	1	1.9	1.9	20	40	1.12	2.13
14.5	1	1.9	1.9	21	40	1.17	2.23
15.5	1	1.9	1.9	18	40	1.01	1.92

Notes: Stream was 20ft across where discharge was taken,
 AA price meter was used to calculate discharge
 AA Velocity equation = $2.2048 \left(\frac{\text{Revs}}{\text{Sec}} \right) + 0.0178$
 $Q = 33.2 \text{ ft}^3/\text{s}$

Figure C-4: Fish Passage Assessment Example Page 4

SITE SKETCH:

- North Arrow
- Direction of Stream Flow
- Culvert/Channel/Road Alignment
- Photo Locations
- Cross Section Location
- Baffle location
- Hydraulic Jump
- Head/Wingwall/Apron Configuration
- Riprap
- Slope Breaks
- Substrate Details
- Other Structures

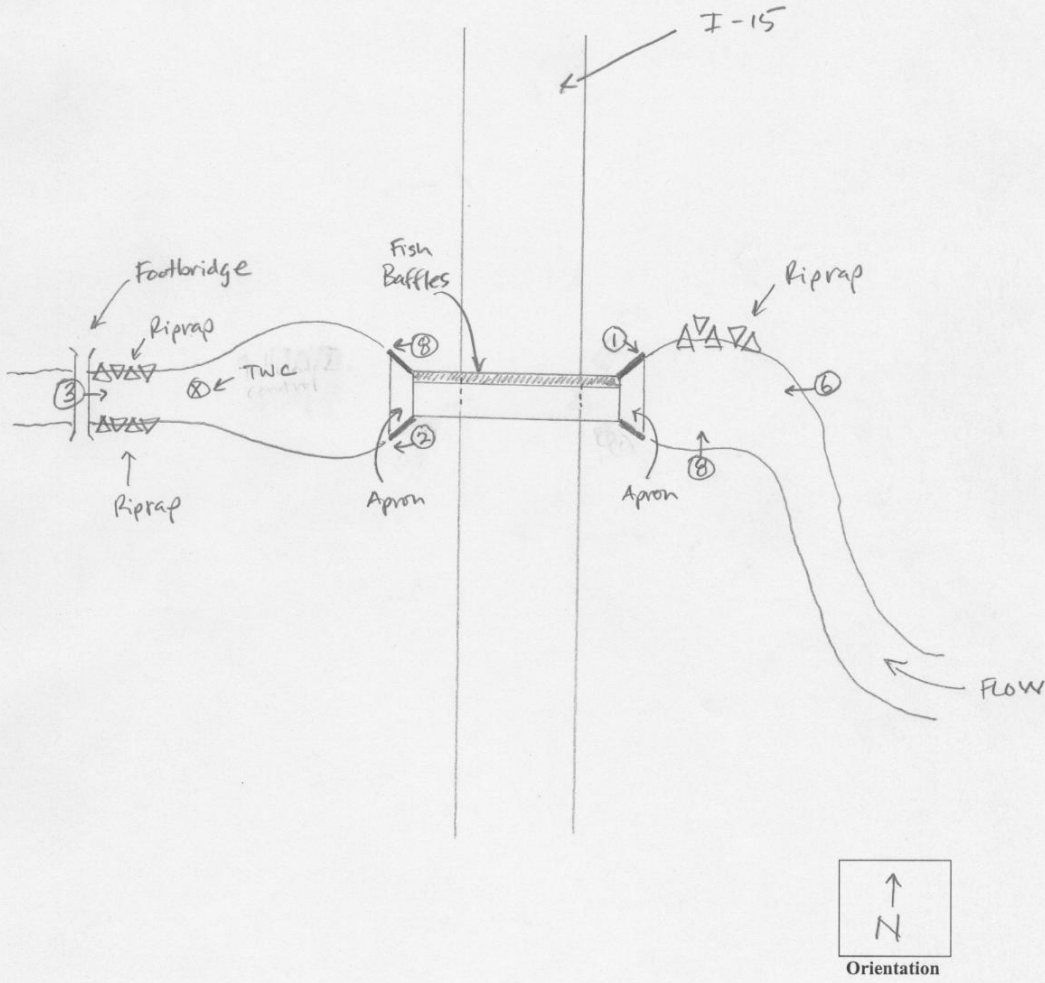

Figure C-5: Fish Passage Assessment Example Page 5